

ROLAPAL

excellence in motion



Visual Code Directory

Contents

CUSHIONS

<i>About “Bubble Contour Series” Cushions</i>	2
<i>Dreamline Assist Cushion</i>	3
<i>Dreamline Support Cushion</i>	3
<i>Dreamline Contour Cushion</i>	3
<i>Dreamline Hi-Contour Cushion</i>	3
<i>About “Adjuster Series” Cushions</i>	4
<i>Dreamline G7 Cushion</i>	5
<i>Dreamline STX2 Cushion</i>	5
<i>Dreamline STX Cushion</i>	5
<i>About “Pressure Redistribution” Cushions</i>	6
<i>Woven Air Cushion</i>	7
<i>Woven Air Sprint Cushion</i>	7
<i>Woven Air G7 Cushion</i>	9
<i>Woven Air STX2 Cushion</i>	9
<i>Dreamline Cushion Accessories</i>	10
<i>Dreamline Cushion Modifications</i>	13

SEAT BASES

<i>Dreamline Quick-Release Seat Pan</i>	20
<i>Dreamline Cushion Rigid Base</i>	20
<i>Dreamline Cushion Rigid Lateral Support</i>	20
<i>Dreamline Seat Base Accessories</i>	21
<i>Dreamline Seat Base Modifications</i>	21

Back Supports

<i>About “Ignite” Series</i>	24
<i>Ignite Active Back Support</i>	26
<i>Ignite Medium Back Support</i>	27
<i>Ignite Deep Back Support</i>	28
<i>Ignite Pro Active (Carbon)</i>	29
<i>Ignite Pro Medium (Carbon)</i>	30
<i>Ignite Pro Deep (Carbon)</i>	31
<i>Ignite Back Support Order Codes</i>	32

Contents *cont.*

<i>Dreamline Contour Back Support</i>	34
<i>About the "Support" Series</i>	36
<i>About STX Back Supports</i>	38
<i>BAC System</i>	39
<i>Dreamline Support Back Support</i>	42
<i>Dreamline S3 Back Support</i>	42
<i>Dreamline STX Back Support</i>	43
<i>Dreamline Back Support Accessories</i>	44
<i>Dreamline Back Support Modifications</i>	50
<i>Corpus Back Support Foam and Cover</i>	52

TRUNK LATERAL SUPPORT HARDWARE

<i>Fixed Trunk Lateral Brackets</i>	58
<i>Original Trunk Swing-away Lateral Brackets</i>	59
<i>Saddleback Trunk Swing-away Lateral Brackets</i>	60
<i>Swing-away Trunk Lateral Pads</i>	62
<i>Swing-away Trunk Lateral Accessories</i>	63
<i>Swing-away Trunk Lateral Modifications</i>	64

HEAD SUPPORT

<i>Saddleback Head Support Brackets</i>	68
<i>Head Support Pads</i>	69
<i>Saddleback Head Support Systems</i>	71
<i>Head Support Accessories</i>	72
<i>Head Support Modifications</i>	73

HIP GUIDES and ARM SUPPORTS

<i>Swing-down/removable Hip/Thigh Guide Brackets</i>	78
<i>Swing-down/removable Hip/Thigh Guide Pads</i>	79
<i>Arm Supports</i>	79
<i>Hip/Thigh Guide and Arm Support Accessories</i>	80
<i>Hip/Thigh Guide and Arm Support Modifications</i>	81

Contents cont.

MEDIAL THIGH SUPPORTS

<i>Swing-down Medial Thigh Support Bracket</i>	86
<i>Swing-down Medial Thigh Support Pad</i>	86
<i>Swing-down Medial Thigh Support Accessories</i>	87
<i>Swing-down Medial Thigh Support Modifications</i>	87

HIP BELTS, HARNESSSES and CALF STRAPS

<i>Harnesses</i>	92
<i>Harness Accessories and Modifications</i>	93
<i>Hip Belts and Accessories</i>	95
<i>Padded Calf Strap and Modifications</i>	99

FASTENERS

<i>Fastener kits etc.</i>	102
<i>Dreamline Service Kits</i>	106

SPLASH

<i>About "Splash" Series</i>	110
<i>Splash Back Supports Order Codes</i>	111
<i>Splash Back Support Accessories</i>	112
<i>Splash Trunk Lateral Support Pads</i>	114
<i>Splash Head Support Pads</i>	115
<i>Splash H2X Harnesses and Pelvic Belts</i>	116

SNOOZA

<i>About "Snooza" Series</i>	120
<i>Snooza Seat Order Codes</i>	121
<i>Snooza Head Supports</i>	122
<i>Snooza Medial Thigh Support</i>	122
<i>Snooza Mobile Bases</i>	123
<i>Snooza Infill Pads</i>	124
<i>Snooza Other Accessories</i>	125

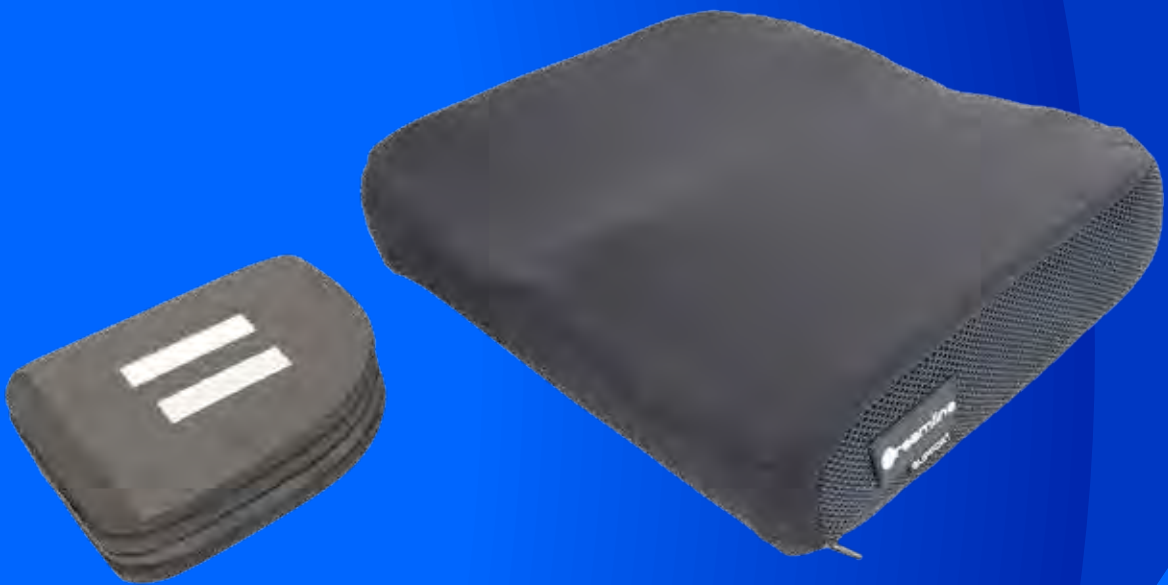

Dreamline Visual Code Directory 2026v1

› *Cushions*

Dreamline Bubble Contour Series

The Dreamline "Bubble Contour" series are foam cushions with unique shaping designed to reduce surface tension enabling more immersion. High Resilient open cell urethane foam with a Sunmate Viscoelastic foam overlay.

Dreamline "Bubble Contour" series all contain a hook receptive loop panel on the underside of the foam inner onto which the Pelvic Obliquity Pads (set of 4 included with each cushion) can be attached for asymmetrical postures.

ASSIST

15mm Contour Profile

SUPPORT

35mm Contour Profile

CONTOUR

60mm Contour Profile

HI-CONTOUR

100mm Contour Profile

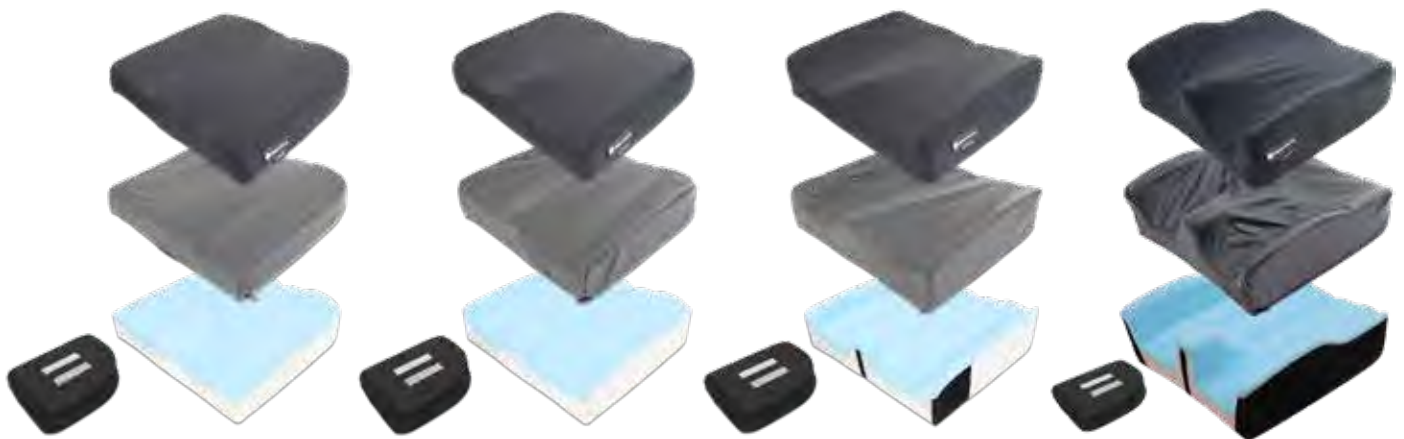

INCLUDED

- Cushion Foam Inner
- Dartex Inner WATER RESISTANT Cover
- Outer Breathable FLO2™ Cover
- Set of 4 Pelvic Obliquity Pads

Height Under User- 65mm

Average weight - 1.8kg

Modifiable? - YES

Custom Sizes? YES



Bubble Contour Series Max User Weight: 120kg (user weight limit can be increased with heavy user mod found on page 13)

BUBBLE SERIES PELVIC OBLIQUITY PAD SIZING CHART

CUSHION (go by shortest width or length of cushion)	8"	10"	12"	14/15"	16/17"	18/19"	20"	22"	24"
PAD WIDTH / LENGTH (mm)	95x95	120x120	140x140	160x160	185x185	210x210	235x235	260x260	285x285
PAD HEIGHT (mm)	10	10	10	10	10	10	10	10	10
CODE (Set of 4)	DCOP8	DCOP10	DCOP12	DCOP14	DCOP16	DCOP18	DCOP20	DCOP22	DCOP24

Custom pads available, use code - DCOPCUST

ACCESSORIES

- Outer Cover only add "OC" to end of code
- Inner Cover only add "IC" to end of code

ASSIST

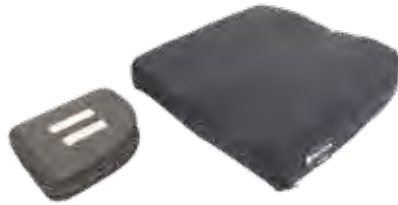

<i>DAC0808</i>	<i>DAC0810</i>	<i>DAC1010</i>	<i>DAC1012</i>	<i>DAC1212</i>	<i>DAC1214</i>	<i>DAC1414</i>
<i>DAC1416</i>	<i>DAC1418</i>	<i>DAC1515</i>	<i>DAC1516</i>	<i>DAC1517</i>	<i>DAC1616</i>	<i>DAC1618</i>
<i>DAC1620</i>	<i>DAC1717</i>	<i>DAC1719</i>	<i>DAC1816</i>	<i>DAC1818</i>	<i>DAC1820</i>	<i>DAC1919</i>
<i>DAC2018</i>	<i>DAC2020</i>	<i>DAC2218</i>	<i>DAC2220</i>	<i>DAC2222</i>	<i>DAC2420</i>	<i>DAC2422</i>
<i>DAC2424</i>	<i>DACCUST</i>	<i>DACCUSTXL</i>				

SUPPORT



<i>DSC0808</i>	<i>DSC0810</i>	<i>DSC1010</i>	<i>DSC1012</i>	<i>DSC1212</i>	<i>DSC1214</i>	<i>DSC1414</i>
<i>DSC1416</i>	<i>DSC1418</i>	<i>DSC1515</i>	<i>DSC1516</i>	<i>DSC1517</i>	<i>DSC1616</i>	<i>DSC1618</i>
<i>DSC1620</i>	<i>DSC1717</i>	<i>DSC1719</i>	<i>DSC1816</i>	<i>DSC1818</i>	<i>DSC1820</i>	<i>DSC1919</i>
<i>DSC2018</i>	<i>DSC2020</i>	<i>DSC2218</i>	<i>DSC2220</i>	<i>DSC2222</i>	<i>DSC2420</i>	<i>DSC2422</i>
<i>DSC2424</i>	<i>DSCCUST</i>	<i>DSCCUSTXL</i>				

CONTOUR



<i>DCC0808</i>	<i>DCC0810</i>	<i>DCC1010</i>	<i>DCC1012</i>	<i>DCC1212</i>	<i>DCC1214</i>	<i>DCC1414</i>
<i>DCC1416</i>	<i>DCC1418</i>	<i>DCC1515</i>	<i>DCC1516</i>	<i>DCC1517</i>	<i>DCC1616</i>	<i>DCC1618</i>
<i>DCC1620</i>	<i>DCC1717</i>	<i>DCC1719</i>	<i>DCC1816</i>	<i>DCC1818</i>	<i>DCC1820</i>	<i>DCC1919</i>
<i>DCC2018</i>	<i>DCC2020</i>	<i>DCC2218</i>	<i>DCC2220</i>	<i>DCC2222</i>	<i>DCC2420</i>	<i>DCC2422</i>
<i>DCC2424</i>	<i>DCCCUST</i>	<i>DCCCUSTXL</i>				

HI-CONTOUR



<i>DHC0808</i>	<i>DHC0810</i>	<i>DHC1010</i>	<i>DHC1012</i>	<i>DHC1212</i>	<i>DHC1214</i>	<i>DHC1414</i>
<i>DHC1416</i>	<i>DHC1418</i>	<i>DHC1515</i>	<i>DHC1516</i>	<i>DHC1517</i>	<i>DHC1616</i>	<i>DHC1618</i>
<i>DHC1620</i>	<i>DHC1717</i>	<i>DHC1719</i>	<i>DHC1816</i>	<i>DHC1818</i>	<i>DHC1820</i>	<i>DHC1919</i>
<i>DHC2018</i>	<i>DHC2020</i>	<i>DHC2218</i>	<i>DHC2220</i>	<i>DHC2222</i>	<i>DHC2420</i>	<i>DHC2422</i>
<i>DHC2424</i>	<i>DHCCUST</i>	<i>DHCCUSTXL</i>				

Dreamline Adjuster Cushion Series

The Adjuster Series gives an advanced toolbox of adjustability and creativity to the clinician to optimise their postural goals for the symmetrical to severely asymmetrical user. Gel Fluid packs in the pelvic region provide dynamic pressure management helping to equalize and redistribute pressure away from at risk regions.

G7

20mm Contour Profile



Height Under User- 75mm
Average weight - 3.2kg
Modifiable? - YES
Custom Sizes? YES

The Dreamline G7 fluid gel cushion is defined by pressure redistribution and positioning personalized to the user.

STX2

80mm Contour Profile



Height Under User- 75mm
Average weight - 3.5kg
Modifiable? - YES
Custom Sizes? YES

The Dreamline STX2 Cushion is a highly supportive deep contoured fluid gel cushion with advanced on-the-spot positioning for the less active user with mild to severely asymmetrical positioning requirements.

INCLUDED

- FLO2™ Outer Breathable Cover
- FLO2™ Inner WATER RESISTANT Cover
- Comfort Wrap

- Gel Fluid Packs x 2
- Positioning Base
- Medial Thigh Support
- Pelvic Obliquity Pads x 4
- Pre-ischial Shelf Wedges x 4



G7 Max User Weight: 135kg

INCLUDED

- FLO2™ Outer Breathable Cover
- FLO2™ Inner WATER RESISTANT Cover
- Comfort Wrap

- Gel Fluid Packs x 2
- Positioning Base
- Medial Thigh Support L / R
- Pelvic Obliquity Pads x 4
- Pre-ischial Shelf Wedges x 4
- Lateral Supports x 2
- Interior Thigh Wedges x 4 (for hip flexion)



STX2 Max User Weight: 135kg

PELVIC OBLIQUITY PAD SIZING FOR G7 AND STX2 CUSHIONS

CUSHION WIDTH	12"	14"/15"	16" / 17"	18"/19"	20"
PAD WIDTH / LENGTH (mm)	55 x 105	70 x 145	95 x 175	120 x 215	145 x 215
PAD HEIGHT (mm)	10	10	10	10	10
CODE (Set of 4)	DXCOP12	DXCOP14	DXCOP16	DXCOP18	DXCOP20

Custom pads available, use code - DCOPCUST

PRE-ISCHIAL WEDGE SIZING FOR G7 AND STX2 CUSHIONS

CUSHION WIDTH	12"	14"/15"	16" / 17"	18"/19"	20"
PAD WIDTH / LENGTH (mm)	60x25	80x25	105x25	130x25	155x25
PAD HEIGHT (mm)	45	45	45	45	45
CODE (Set of 4)	DX2CPIW12	DX2CPIW14	DX2CPIW16	DX2CPIW18	DX2CPIW20

Custom wedges available, use code - DX2CPIW1CUST for up to 20" wide and DX2CPIWCUSTXL for 21"-28"

G7 CUSHION- with gel



D7C1212	D7C1214	D7C1414	D7C1416	D7C1418	D7C1515	D7C1516
D7C1517	D7C1616	D7C1618	D7C1620	D7C1717	D7C1719	D7C1816
D7C1818	D7C1820	D7C1822	D7C1919	D7C2018	D7C2020	D7CCUST
D7CCUSTXL						

ACCESSORIES - Outer Cover only add "OC" to end of code • Inner Cover only add "IC" to end of code
 SPARE PARTS - Base only add "B" to end of code • Comfort Wrap only add "CW" to end of code

STX2 CUSHION - with gel



DX2C1212	DX2C1214	DX2C1414	DX2C1416	DX2C1418	DX2C1515	DX2C1516
DX2C1517	DX2C1616	DX2C1618	DX2C1620	DX2C1717	DX2C1719	DX2C1816
DX2C1818	DX2C1820	DX2C1822	DX2C1919	DX2C2018	DX2C2020	DX2CCUST
DX2CCUSTXL						

ACCESSORIES - Outer Cover only add "OC" to end of code • Inner Cover only add "IC" to end of code
 SPARE PARTS - Base only add "B" to end of code • Comfort Wrap only add "CW" to end of code

STX Cushion

80mm Contour Profile



Height Under User- 65mm
 Average weight - 3.5kg
 Modifiable? - YES
 Custom Sizes? YES

These Gel cushions provide clinicians with multiple adjustment options to suit both symmetrical and asymmetrical postures. The STX features an 80mm high contour profile with a slimmer design under the user, incorporating dry cluster gel packs for a lighter-weight, comfortable solution.

INCLUDED

- Polyester Knit Outer Breathable Cover
- Dartex™ Inner WATER RESISTANT Cover
- Comfort Wrap
- Gel or Foam Cluster Packs
- Positioning Base

- Medial Thigh Support L / R
- Pre-ischial Shelf Wedge x 1
- Pre-ischial Shelf Pieces x 2
- Lateral Supports x 2
- BAC Positioning Pads (10pk)



STX Max User Weight: 135kg

STX Cushion - with gel

DXC1212	DXC1214	DXC1414	DXC1416	DXC1418	DXC1616	DXC1618
DXC1620	DXC1717	DXC1816	DXC1818	DXC1820	DXC1822	DXC2018
DXC2020	DXCCUST	DXCCUSTXL				

ACCESSORIES - Outer Cover only add "OC" to end of code • Inner Cover only add "IC" to end of code
 SPARE PARTS - Base only add "B" to end of code • Comfort Wrap only add "CW" to end of code

STX Cushion - with foam

DXCF1212	DXCF1214	DXCF1414	DXCF1416	DXCF1418	DXCF1616	DXCF1618
DXCF1620	DXCF1717	DXCF1816	DXCF1818	DXCF1820	DXCF1822	DXCF2018
DXCF2020	DXCFCUST	DXCFCUSTXL				

ACCESSORIES - Outer Cover only add "OC" to end of code • Inner Cover only add "IC" to end of code
 SPARE PARTS - Base only add "B" to end of code • Comfort Wrap only add "CW" to end of code

Rolapal Pressure Redistribution Cushions

Rolapal pressure redistribution cushions have been carefully designed to effectively redistribute pressure while maintaining a stable base for the user.

Rolapal uses two main mediums for effective pressure redistribution; Air and Gel Fluid packs. These two medium have a very different feel but achieve a similar result.

Gel Fluid packs have a solid feel making the cushion very stable but are heavier while Air cushions have a more spongy feel and are lightweight.

WOVEN AIR CUSHION



"Flotation without inflation"

The Rolapal Woven Air cushion offers excellent lateral stability and true flotation pressure redistribution. It is very low maintenance and does not require ongoing inflation. If damaged, individual air tubes can be replaced.

Positioning pads such as Pelvic Obliquity pads are able to be attached to the underside of the Woven Air cushion or to the Contour Base.

WOVEN AIR SPRINT CUSHION



The Rolapal Woven Air Sprint Cushion is an ultra-lightweight, slim cushion that features a stable closed-cell foam base. It provides extra support under the thighs and incorporates Woven Air technology in the ischial region, making it an excellent choice for self-propelling users.

Positioning pads such as Pelvic Obliquity pads are able to be attached to the underside of the Woven Air cushion or to the Contour Base.

INCLUDED

- FLO2™ Outer WATER RESISTANT Cover
- Inner air Pocket
- For cushions 14" and 15" wide, 16 Woven Air tubes 70mm high
- For cushions >16" wide, 16 Woven Air tubes 90mm high (except for 16"x 20", and 18"x20" and above which have 20 tubes)



Max User
Weight: 180kg

Height Under User-55mm

INCLUDED

- FLO2™ Outer WATER RESISTANT Cover
- Positioning base
- Comfort wrap for thigh region
- Air Pocket insert
- Air Tubes x 8 70mm high (apart from 16"x 20", and 18"x20" and above which have 10 tubes)



Max User
Weight: 180kg

Height Under User-65mm

PELVIC OBLIQUITY PAD SIZING CHART - WOVEN AIR AND SPRINT CUSHIONS

CUSHION (shortest width or length of cushion)	14"/15"	16"/17"	18"/19"	20"
PAD WIDTH / LENGTH (mm)	160x160	185x185	210x210	235x235
PAD HEIGHT (mm)	10	10	10	10
CODE (Set of 4)	DCOP14	DCOP16	DCOP18	DCOP20

Custom pads available, use code - DCOPCUST

WOVEN AIR CUSHION



WAC1414	WAC1416	WAC1418	WAC1515	WAC1516	WAC1517	WAC1616
WAC1618	WAC1620	WAC1717	WAC1719	WAC1816	WAC1818	WAC1820
WAC1822	WAC1919	WAC2018	WAC2020	WACCUST	WACCUSTXL	

Accessories - Outer Cover only add "OC" to end of code • Inner Cover only add "IC" to end of code
Spare Parts - Air Pocket only add "AP" to end of the code

WOVEN AIR SPRINT CUSHION



WSC1414	WSC1416	WSC1418	WSC1515	WSC1516	WSC1517	WSC1616
WSC1618	WSC1620	WSC1717	WSC1719	WSC1816	WSC1818	WSC1820
WSC1822	WSC1919	WSC2018	WSC2020	WSCCUST	WSCCUSTXL	

Accessories - Outer Cover only add "OC" to end of code • Inner Cover only add "IC" to end of code
Spare Parts - Air Pocket only add "AP" to end of the code • Thigh Pad only add "CW" to the end of the code

WOVEN AIR TUBES SPARE PARTS

The first two numbers after WAT refer to the width of the cushion



CODE	DESCRIPTION	TUBE LENGTH (mm)	QTY
WAT1470	Woven Air Tube 14" x 70mm (for Sprint/Woven Air Cushions)	870	4pk
WAT1570	Woven Air Tube 15" x 70mm (for Sprint/Woven Air Cushions)	930	4pk
WAT1670	Woven Air Tube 16" x 70mm (for Sprint Cushions)	990	4pk
WAT1770	Woven Air Tube 17" x 70mm (for Sprint Cushions)	1050	4pk
WAT1870	Woven Air Tube 18" x 70mm (for Sprint Cushions)	1110	4pk
WAT1970	Woven Air Tube 19" x 70mm (for Sprint Cushions)	1150	4pk
WAT2070	Woven Air Tube 20" x 70mm (for Sprint Cushions)	1200	4pk
WAT70CUSTXL	Woven Air Tube from 22" x 70mm (for Sprint Cushions)	up to 1400	4pk
WAT1690	Woven Air Tube 16" x 90mm (for Woven Air Cushions)	990	4pk
WAT1790	Woven Air Tube 17" x 90mm (for Woven Air Cushions)	1050	4pk
WAT1890	Woven Air Tube 18" x 90mm (for Woven Air Cushions)	1100	4pk
WAT1990	Woven Air Tube 19" x 90mm (for Woven Air Cushions)	1150	4pk
WAT2090	Woven Air Tube 20" x 90mm (for Woven Air Cushions)	1200	4pk
WAT90CUSTXL	Woven Air Tube from 22" x 90mm (for Woven Air Cushions)	up to 1400	4pk

**WOVEN AIR
CONTOUR BASE**

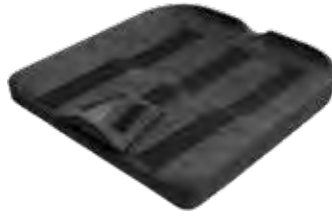

Fits inside the cover and adds pre-ischial shelf and mild lateral contouring to the Woven Air Cushion.

<i>WAC1414CB</i>	<i>WAC1416CB</i>	<i>WAC1418CB</i>	<i>WAC1515CB</i>	<i>WAC1516CB</i>	<i>WAC1517CB</i>	<i>WAC1616CB</i>
<i>WAC1618CB</i>	<i>WAC1620CB</i>	<i>WAC1717CB</i>	<i>WAC1719CB</i>	<i>WAC1816CB</i>	<i>WAC1818CB</i>	<i>WAC1820CB</i>
<i>WAC1822CB</i>	<i>WAC1919CB</i>	<i>WAC2018CB</i>	<i>WAC2020CB</i>	<i>WACCUSTCB</i>	<i>WACCUSTXLCB</i>	

**WOVEN AIR
ADJUSTABLE BASE**

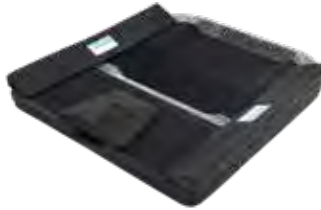

The Woven Air Adjustable Positioning Base is characterized by an ischial well and wide trochanteric shelves to offload the IT's redistributing pressure to the femurs / thighs. Removable thigh wedges enable the prescriber to lower each thigh individually to accommodate Hamstring contractures. Fits inside the cover.

Components	<ul style="list-style-type: none"> • 1 x Positioning Base • 2 x Thigh Wedges • 2 x Laterals • 1 x Medial Thigh Support
Construction	EVA Closed Cell Foam
Positioning Base Height	25mm
Laterals and Medial Thigh Support Height	20mm
Pre-Ischial Shelf Height	20mm

<i>WAC1414AB</i>	<i>WAC1416AB</i>	<i>WAC1418AB</i>	<i>WAC1515AB</i>	<i>WAC1516AB</i>	<i>WAC1517AB</i>	<i>WAC1616AB</i>
<i>WAC1618AB</i>	<i>WAC1620AB</i>	<i>WAC1717AB</i>	<i>WAC1719AB</i>	<i>WAC1816AB</i>	<i>WAC1818AB</i>	<i>WAC1820AB</i>
<i>WAC1822AB</i>	<i>WAC1919AB</i>	<i>WAC2018AB</i>	<i>WAC2020AB</i>	<i>WACCUSTAB</i>	<i>WACCUSTXLAB</i>	

G7 CUSHION- with Woven Air

D7CW1414	D7CW1416	D7CW1418	D7CW1515
D7CW1516	D7CW1517	D7CW1616	D7CW1618
D7CW1620	D7CW1717	D7CW1719	D7CW1816
D7CW1818	D7CW1820	D7CW1822	D7CW1919
D7CW2018	D7CW2020	D7CWCUST	D7CWCUSTXL

ACCESSORIES

- Outer Cover only add "OC" to end of ORIGINAL G7 code
- Inner Cover only add "IC" to end of ORIGINAL G7 code

SPARE PARTS

- Comfort Wrap only add "CW" to end of code
- Air Pocket only add "AP" to end of the code



STX2 CUSHION - with Woven Air

DX2CW1414	DX2CW1416	DX2CW1418	DX2CW1515
DX2CW1516	DX2CW1517	DX2CW1616	DX2CW1618
DX2CW1620	DX2CW1717	DX2CW1719	DX2CW1816
DX2CW1818	DX2CW1820	DX2CW1822	DX2CW1919
DX2CW2018	DX2CW2020	DX2CWCUST	DX2CWCUSTXL

ACCESSORIES

- Outer Cover only add "OC" ORIGINAL STX2 code
- Inner Cover only add "IC" ORIGINAL STX2 code

SPARE PARTS

- Comfort Wrap only add "CW" to end of code
- Air Pocket only add "AP" to end of the code



WOVEN AIR INSERT

for STX2 and G 7 (6cm high)



WAI1414	WAI1416	WAI1418	WAI1515	WAI1516	WAI1517	WAI1616
WAI1618	WAI1620	WAI1717	WAI1719	WAI1816	WAI1818	WAI1820
WAI1822	WAI1919	WAI2018	WAI2020	WAICUST	WAICUSTXL	

WOVEN AIR TUBES

SPARE PARTS

The first two numbers after WAT refer to the width of the cushion



CODE	DESCRIPTION	TUBE LENGTH (mm)	QTY
WAT1460	Woven Air Tube 14" x 60mm (for STX2/G7 Cushions)	750	4pk
WAT1560	Woven Air Tube 15" x 60mm (for STX2/G7 Cushions)	810	4pk
WAT1660	Woven Air Tube 16" x 60mm (for STX2/G7 Cushions)	870	4pk
WAT1760	Woven Air Tube 17" x 60mm (for STX2/G7 Cushions)	930	4pk
WAT1860	Woven Air Tube 18" x 60mm (for STX2/G7 Cushions)	990	4pk
WAT1960	Woven Air Tube 19" x 60mm (for STX2/G7 Cushions)	1050	4pk
WAT2060	Woven Air Tube 20" x 60mm (for STX2/G7 Cushions)	1110	4pk
WAT60CUSTXL	Woven Air Tube from 22" x 60mm (for STX2/G7 Cushions)	up to 1200	4pk

Dreamline Cushion Accessories

**PELVIC OBLIQUITY
PADS FOR BUBBLE
CONTOUR SERIES AND
WOVEN AIR SERIES**

(SET OF 4)



DCOP8	DCOP10	DCOP12	DCOP14	DCOP16
DCOP18	DCOP20	DCOP22	DCOP24	DCOPCUST

(see sizing on page 2 for bubble series and page 6 for woven air series)

**PELVIC OBLIQUITY
PADS FOR G7 AND STX2
CUSHIONS**

(SET OF 4)

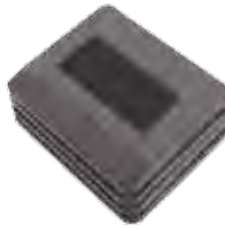

DXCOP12	DXCOP14	DXCOP16	DXCOP18	DXCOP20	DXCOPCUST
---------	---------	---------	---------	---------	-----------

(see sizing on page 4)

**PRE-ISCHIAL SHELF WEDGES
FOR
G7 AND STX2 CUSHIONS**

(SET OF 4)



DX2CPIW12	DX2CPIW14	DX2CPIW15	DX2CPIW16	DX2CPIW17
DX2CPIW18	DX2CPIW19	DX2CPIW20	DX2CPIWCUST	DX2CPIWCUSTXL

**G7 MEDIAL
THIGH SUPPORT**

(20MM HIGH)



SMALL	DGCPOMSML	Cushions up to 16"x16"
LARGE	DGCPOMLGE	Cushions 16"x16 and above

**STX2 MEDIAL
THIGH SUPPORT**

(80MM HIGH)

Use Small for Cushions 17" and less
and large for 18" and more



SMALL	LEFT	DXCPOML4
	RIGHT	DXCPOMR4
LARGE	LEFT	DXCPOML6
	RIGHT	DXCPOMR6

Dreamline Cushion Accessories cont.

LATERALS FOR STX2 CUSHIONS

(80MM HIGH)



FOR CUSHION LENGTH (inch)	12"	14"	15"	16"	17"	18"
CUSHION LENGTH (mm)	220	270	295	320	345	370
CODE	DX2CLAT12	DX2CLAT14	DX2CLAT15	DX2CLAT16	DX2CLAT17	DX2CLAT18

CUSHION LENGTH (inch)	19"	20"	22"	Custom	Custom
CUSHION LENGTH (mm)	395	420	470	Custom	Custom
CODE	DX2CLAT19	DX2CLAT20	DX2CLAT22	DX2CLATCUST	DX2CLATCUSTXL

LOW LATERAL SEGMENTS FOR STX2 CUSHIONS

(40MM HIGH)



LENGTH (mm)	220	270	295	320	345
CODE	DX2CLLAT12	DX2CLLAT14	DX2CLLAT15	DX2CLLAT16	DX2CLLAT17
LENGTH (mm)	370	395	420	Custom	Custom
CODE	DX2CLLAT18	DX2CLLAT19	DX2CLLAT20	DX2CLLATCUST	DX2CLLATCUSTXL

SEGMENTS FOR STX2 CUSHIONS

(80MM HIGH)

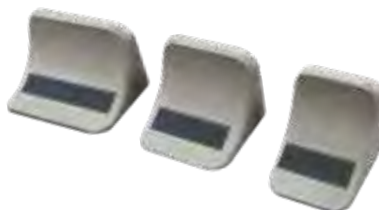

CUSHION LENGTH (mm)	75	100	150
CODE	DXCLAT3	DXCLAT4	DXCLAT6

STX2 EXTRA THIGH WEDGE (FOR HIP FLEXION)

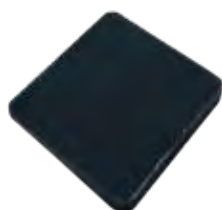

DX2CTW12	DX2CTW14	DX2CTW16
DX2CTW17	DX2CTW18	DX2CTW20
DX2CTWCUST		

Dreamline Cushion Accessories cont.

SUNMATE CLUSTER PACK

DCSFB46



RESILIENT FOAM CLUSTER PACK

DCRF46



GEL CLUSTER PACK

DCG46



STX BAC PADS 10 KIT

DXCBACKIT



CUSHION GEL WRAP

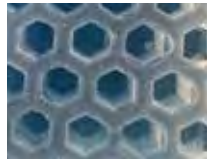

DCGW0808	DCGW0810	DCGW1010	DCGW1012	DCGW1212	DCGW1214	DCGW1414
DCGW1416	DCGW1418	DCGW1515	DCGW1516	DCGW1517	DCGW1616	DCGW1618
DCGW1620	DCGW1717	DCGW1719	DCGW1816	DCGW1818	DCGW1820	DCGW1822
DCGW1919	DCGW2018	DCGW2020	DCGW2218	DCGW2220	DCGW2222	DCGW2420
DCGW2422	DCGW2424	DCGWCUST	DCGWCUSTXL			

GEL FLUID PACK DIMENSIONS FOR G7 AND STX2 CUSHIONS



CUSHION SIZE	CODE - For one bag	WIDTH X LENGTH (mm)
Any	DCGFP46	100 x 150
12x12	DCGFP1212	155 x 185
12x14	DCGFP1214	155 x 210
14x14 / 15x15	DCGFP1414	180 x 210
14x16 / 15x16 / 15x17	DCGFP1416	180 x 250
14x18	DCGFP1418	180 x 280
16x16 / 17x17	DCGFP1616	205 x 250
16x18 / 17x19	DCGFP1618	205 x 280
16x20	DCGFP1620	205 x 320
18x16	DCGFP1816	230 x 250
18x18 / 19x19	DCGFP1818	230 x 280
18x20	DCGFP1820	230 x 320
18x22	DCGFP1822	230 x 360
20x18	DCGFP2018	255 x 280
20x20	DCGFP2020	255 x 320
Custom up to 20" wide x 22" long	DCGFPCUST	Custom
Custom from 21" - 28" wide & 23" - 24" long	DCGFPCUSTXL	Custom
15% gel overfill	DCMODGOF	Modification

Cushion Modifications

**CUSHION TAPERED
SIDES MOD**



DCMODTS

**STX2 CUSTOM HEIGHT
LATERAL THIGH
SUPPORT MOD**

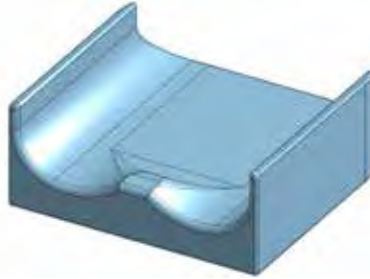

DXCMODCL

**STX2 CUSTOM HEIGHT
MEDIAL THIGH
SUPPORT MOD**

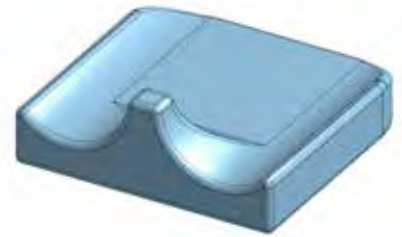

DXMODCP

**CUSTOM HEIGHT
LATERAL THIGH
SUPPORT MOD (OTHER)**

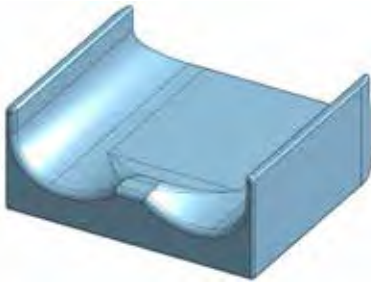

DCMODCL

**CUSTOM HEIGHT
MEDIAL THIGH
SUPPORT MOD (OTHER)**

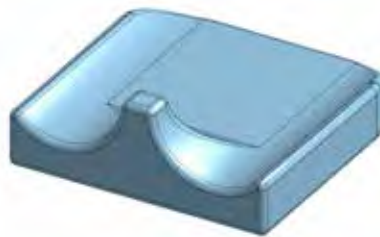

DCMODCP

**STX2 CUSTOM ISCHIAL
WELL MOD**

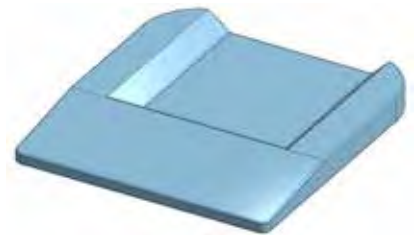

DXCMODCIW

**STX2 CUSTOM
HEIGHT MOD**

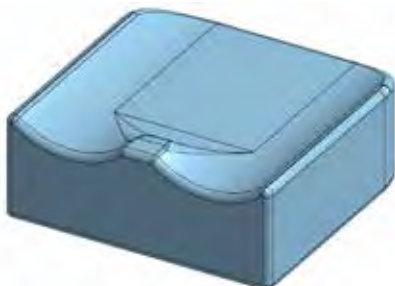

DXCMODEH

**CUSTOM HEIGHT
MOD (OTHER)**

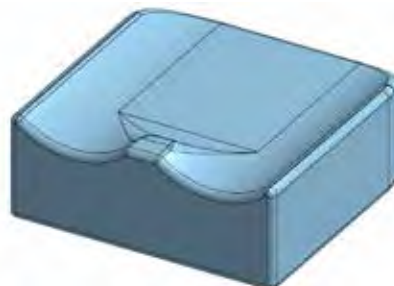

DCMODEH

**REAR CORNER
CUT-OUT MOD**



DCMODCC

Cushion Modifications *cont.*

**ADD FOAM
RAMP MOD**



DCMODFR

**REMOVE CUSHION
FRONT HALF LATERAL
THIGH SUPPORT**



DCMODRFL

**REMOVE CUSHION
REAR HALF LATERAL
THIGH SUPPORT**



DCMODRRL

**REMOVE LATERAL
CONTOURING MOD**

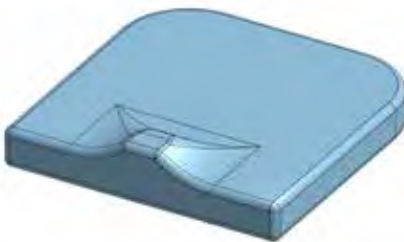

DCMODRL

**REMOVE MEDIAL THIGH
SUPPORT CONTOURING
MOD**

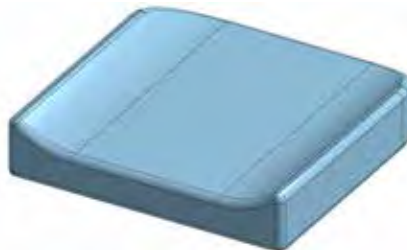

DCMODRP

**FRONT BEVEL
UNDERCUT**



DCMODFBU1

DCMODFBU2

**ADD 1/2" SUNMATE
FOAM OVERLAY MOD**

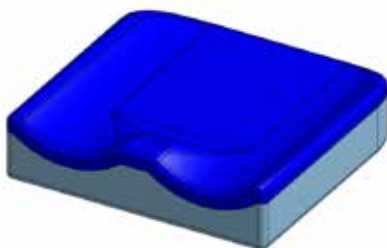

DCMODSFO

**ADD EXTRA FOAM FOR
HEAVY USER MOD**



DCMODEF

Apply this modification when user is above the max user weight of the cushion and advise Rolapal the weight of the user

**DARTEX FABRIC
SMOOTH MOD**

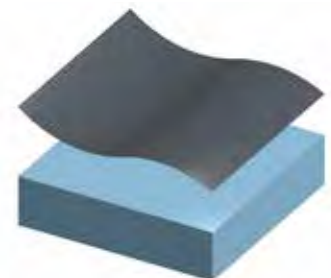

DCMODCPU

Cushion Modifications *cont.*

CUSTOM FABRIC MOD
(ORIGINAL FABRIC OR SPECIFY)

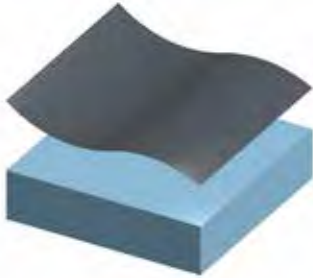

DCMODCF

LEFT LEG DISCREPANCY CUT-OUT MOD



<i>DCMODLLDL1</i>	<i>DCMODLLDL2</i>
<i>DCMODLLDL3</i>	<i>DCMODLLDL4</i>
<i>DCMODLLDL5</i>	<i>DCMODLLDL6</i>

RIGHT LEG DISCREPANCY CUT-OUT MOD



<i>DCMODLLDR1</i>	<i>DCMODLLDR2</i>
<i>DCMODLLDR3</i>	<i>DCMODLLDR4</i>
<i>DCMODLLDR5</i>	<i>DCMODLLDR6</i>

CUSHION CUSTOM HANDLE MOD



DCMODH

CUSHION CUSTOM POUCH MOD



DCMODP

Cushion Modifications *cont.*

COLOUR MOD
RED



DCMODRED

COLOUR MOD
BLUE



DCMODBLU

COLOUR MOD
ORANGE



DCMODORA

COLOUR MOD
GREEN



DCMODGRE

COLOUR MOD
PURPLE



DCMODPUR

COLOUR MOD
YELLOW



DCMODYEL

COLOUR MOD
SILVER



DCMODSIL

COLOUR MOD
PINK



DCMODPIN

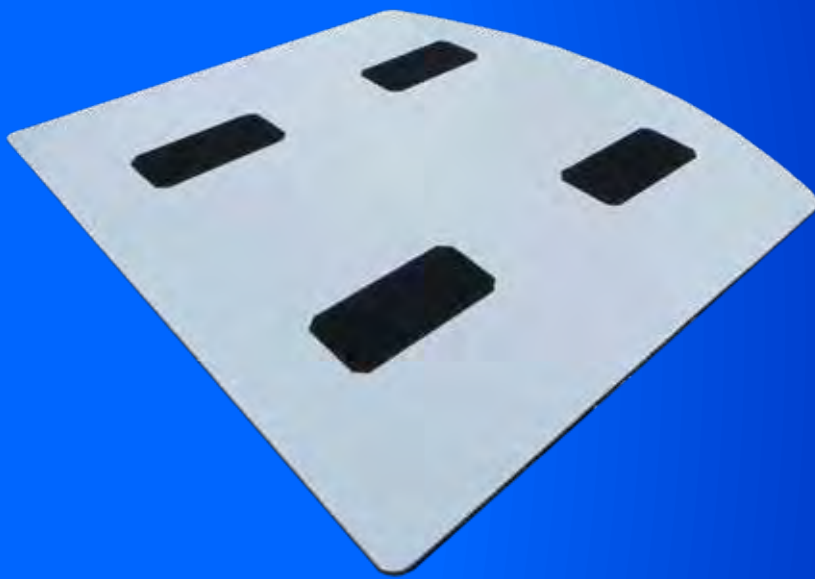

Dreamline Visual Code Directory 2026

› Seat Bases

Seat Bases

QUICK-RELEASE SEAT PAN



DSP1212	DSP1214	DSP1414	DSP1416	DSP1418	DSP1616	DSP1618
DSP1620	DSP1818	DSP1820	DSP2020	DSPCUST	DSPCUSTXL	

- *Grab and Go. Intuitive lift tab and lift away release system.*
- *Dreamline quick-release seat pans are 5mm narrower overall than the wheelchair width.*
- *Dreamline quick-release seat pans are 15mm shorter than cushion seat depth. (Allows for cushion overhang to protect occupant from seat pan front edge.)*
- *Includes fasteners for Hip Guide / Arm Support and Hip Belt attachment.*

CUSHION RIGID BASE



DCRB0808	DCRB0810	DCRB1010	DCRB1012	DCRB1212	DCRB1214	DCRB1414
DCRB1416	DCRB1418	DCRB1515	DCRB1517	DCRB1519	DCRB1616	DCRB1618
DCRB1620	DCRB1717	DCRB1719	DCRB1816	DCRB1818	DCRB1820	DCRB1919
DCRB2018	DCRB2020	DCRB2218	DCRB2220	DCRB2222	DCRB2420	DCRB2422
DCRB2424	DCRBCUST	DCRBCUSTXL				

- *Cushion rigid bases are 40mm narrower overall than the cushion width (they are designed to fit between the seat rails and tighten the upholstery).*
- *Cushion rigid bases are 30mm smaller than cushion depth to protect the user.*

CUSHION RIGID LATERAL SUPPORT



DCRL08	DCRL10	DCRL12	DCRL14	DCRL16	DCRL17	DCRL18
DCRL20	DCRL22	DCRL24	DCRLCUST	DCRLCUSTXL		

- *The Dreamline Cushion Rigid Lateral is a durable, lightweight polypropylene plastic insert that attaches securely to the foam inner of Dreamline cushions. It enhances lateral thigh support for improved stability.*

Seat Base Accessories

SEAT PAN UTILITY RAIL

Fits to the Quick-release Seat Pan for easy and secure Hip-belt, Hip thigh guide and Arm Support attachment.



FITS SEAT PAN (LENGTH)	12"	14"	16" / 17"	18"	20"
CODE	DSPUR200	DSPUR250	DSPUR300	DSPUR350	DSPUR400

SEAT PAN CLAMP KIT FOR 2ND MOBILITY BASE

DSPCKIT



POSITIONING CLAMPS (PR)

DSPCF



• Can be used for hip-belt and hanes attachment

Seat Base Modifications

SUITS SEAT BASES, CUSHION RIGID BASES AND CUSHION RIGID LATERAL SUPPORTS

LEFT LEG LENGTH DISCREPANCY CUT-OUT MOD



DSPMODLLDL1
DSPMODLLDL2
DSPMODLLDL3
DSPMODLLDL4
DSPMODLLDL5
DSPMODLLDL6

RIGHT LEG LENGTH DISCREPANCY CUT-OUT MOD

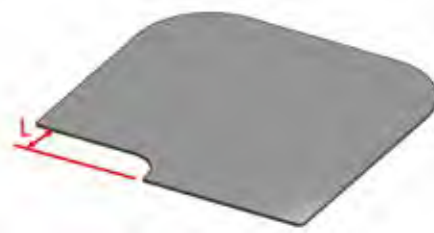

DSPMODLLDR1
DSPMODLLDR2
DSPMODLLDR3
DSPMODLLDR4
DSPMODLLDR5
DSPMODLLDR6



Dreamline Visual Code Directory 2026

› *Back Supports*

Ignite Series *2 types*

IGNITE (ALUMINIUM)



IGNITE PRO (CARBON)



3 contour depths for each type

IGNITE ACTIVE



IGNITE MEDIUM



IGNITE DEEP



From their comfortable pressure redistribution technology to their easy-to-use compact hardware and sporty appeal, the lightweight Ignite back support system is a pleasure to use.

Attachment Options

SHELL AND PAD ONLY
(NO HARDWARE)



FIXED HARDWARE



QUICK-RELEASE HARDWARE



INCLUDED

SHELL and PAD ONLY

- Back Support Shell
- Foam Inner
- FLO2™ Outer Cover
- Lumbar Pad
- Lateral Stability Wedges x 2
- Mini Lateral Stability Wedges x 2

FIXED

- Back Support Shell with L-brackets and clamps
- Foam Inner
- FLO2™ Outer Cover
- Lumbar Pad
- Lateral Stability Wedges x 2
- Mini Lateral Stability Wedges x 2

QUICK-RELEASE

- Back Support Shell with L-brackets and pins
- Foam Inner
- FLO2™ Outer Cover
- Lumbar Pad
- Lateral Stability Wedges x 2
- Mini Lateral Stability Wedges x 2
- Clamps (1 x Left / 1 x Right)
- Mini Pins x 4
- Pin shrouds x 2

• NOTE: Ignite Pro Medium and Deep Back Supports include an extra pack of 2 M6 x 16mm coach bolts with washers and nuts for when offsetting the lateral trunk support.

Ignite Lateral Options

New Ignite Laterals enable you to get the deep contour with separate covered laterals to allow adjustability. Use either the DIBA (Active Aluminium or DPBA (Pro Active Carbon) and add the Deep Laterals (DIBALD)



IGNITE ACTIVE BACK SUPPORT LATERAL - DEEP

DIBALD
DIBALDS



IGNITE ACTIVE BACK SUPPORT OFFSET LATERAL BRACKETS

DIBAOL

Sold in pairs



IGNITE BACK SUPPORT SHELL DIMENSIONS

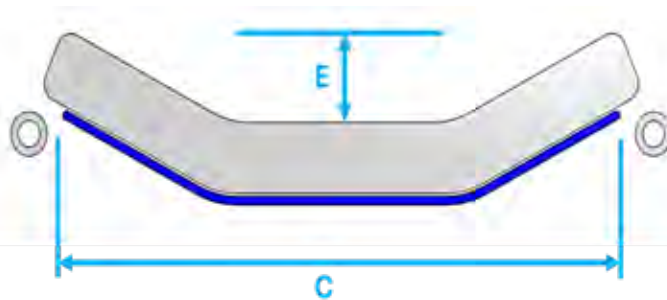

CODE (QUICK-RELEASE)	SIZE (width x height)	A (Back Support shell height)	B (Centre of Lateral Posi)	C (Back Support O/A width)	D (between laterals)	E (Lateral depth)
ACTIVE CONTOUR (ALUMINIUM)						
DIBA1407	14" x 07"	170mm	-	285mm	-	40mm
DIBA1409	14" x 09"	230mm	-	285mm	-	40mm
DIBA1412	14" x 12"	300mm	-	285mm	-	40mm
DIBA1414	14" x 14"	350mm	-	285mm	-	40mm
DIBA1416	14" x 16"	400mm	-	285mm	-	40mm
DIBA1507	15" x 07"	170mm	-	310mm	-	40mm
DIBA1509	15" x 09"	230mm	-	310mm	-	40mm
DIBA1512	15" x 12"	300mm	-	310mm	-	40mm
DIBA1514	15" x 14"	350mm	-	310mm	-	40mm
DIBA1516	15" x 16"	400mm	-	310mm	-	40mm
DIBA1608	16" x 08"	200mm	-	335mm	-	45mm
DIBA1610	16" x 10"	250mm	-	335mm	-	45mm
DIBA1613	16" x 13"	330mm	-	335mm	-	45mm
DIBA1616	16" x 16"	400mm	-	335mm	-	45mm
DIBA1618	16" x 18"	450mm	-	335mm	-	45mm
DIBA1708	17" x 08"	200mm	-	360mm	-	45mm
DIBA1710	17" x 10"	250mm	-	360mm	-	45mm
DIBA1713	17" x 13"	330mm	-	360mm	-	45mm
DIBA1716	17" x 16"	400mm	-	360mm	-	45mm
DIBA1718	17" x 18"	450mm	-	360mm	-	45mm
DIBA1808	18" x 08"	200mm	-	385mm	-	50mm
DIBA1810	18" x 10"	250mm	-	385mm	-	50mm
DIBA1813	18" x 13"	330mm	-	385mm	-	50mm
DIBA1816	18" x 16"	400mm	-	385mm	-	50mm
DIBA1818	18" x 18"	450mm	-	385mm	-	50mm
DIBA2008	20" x 08"	200mm	-	435mm	-	50mm
DIBA2010	20" x 10"	250mm	-	435mm	-	50mm
DIBA2013	20" x 13"	330mm	-	435mm	-	50mm
DIBA2016	20" x 16"	400mm	-	435mm	-	50mm
DIBA2018	20" x 18"	450mm	-	435mm	-	50mm
DIBACUST	XXXX	XXXX	Proportional	XXXX	XXXX	Proportional
DIBACUSTXL	XXXX	XXXX	Proportional	XXXX	XXXX	Proportional

IGNITE BACK SUPPORT SHELL DIMENSIONS

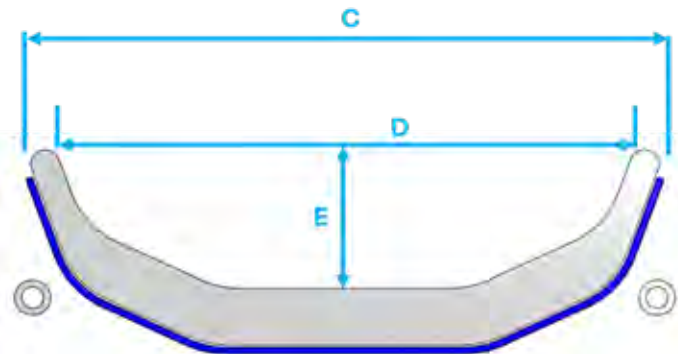
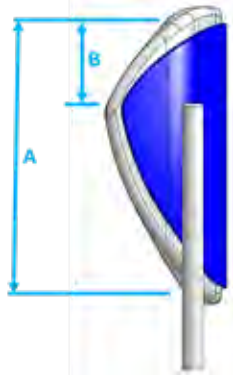

CODE (QUICK-RELEASE)	SIZE (width x height)	A (Back Support shell height)	B (Centre of Lateral Posi)	C (Back Support O/A width)	D (between laterals)	E (Lateral depth)
MEDIUM CONTOUR (ALUMINIUM)						
DIBM1407	14" x 07"	170mm	80mm	340mm	295mm	85mm
DIBM1409	14" x 09"	230mm	90mm	340mm	295mm	85mm
DIBM1412	14" x 12"	300mm	115mm	340mm	295mm	85mm
DIBM1414	14" x 14"	350mm	145mm	340mm	295mm	85mm
DIBM1416	14" x 16"	400mm	170mm	340mm	295mm	85mm
DIBM1507	15" x 07"	170mm	80mm	360mm	315mm	85mm
DIBM1509	15" x 09"	230mm	90mm	360mm	315mm	85mm
DIBM1512	15" x 12"	300mm	115mm	360mm	315mm	85mm
DIBM1514	15" x 14"	350mm	145mm	360mm	315mm	85mm
DIBM1516	15" x 16"	400mm	170mm	360mm	315mm	85mm
DIBM1608	16" x 08"	200mm	90mm	390mm	345mm	100mm
DIBM1610	16" x 10"	250mm	96mm	390mm	345mm	100mm
DIBM1613	16" x 13"	330mm	120mm	390mm	345mm	100mm
DIBM1616	16" x 16"	400mm	165mm	390mm	345mm	100mm
DIBM1618	16" x 18"	450mm	195mm	390mm	345mm	100mm
DIBM1708	17" x 08"	200mm	90mm	415mm	370mm	100mm
DIBM1710	17" x 10"	250mm	96mm	415mm	370mm	100mm
DIBM1713	17" x 13"	330mm	120mm	415mm	370mm	100mm
DIBM1716	17" x 16"	400mm	165mm	415mm	370mm	100mm
DIBM1718	17" x 18"	450mm	195mm	415mm	370mm	100mm
DIBM1808	18" x 08"	200mm	90mm	440mm	395mm	100mm
DIBM1810	18" x 10"	250mm	96mm	440mm	395mm	100mm
DIBM1813	18" x 13"	330mm	120mm	440mm	395mm	100mm
DIBM1816	18" x 16"	400mm	165mm	440mm	395mm	100mm
DIBM1818	18" x 18"	450mm	195mm	440mm	395mm	100mm
DIBM2008	20" x 08"	200mm	90mm	490mm	445mm	100mm
DIBM2010	20" x 10"	250mm	96mm	490mm	445mm	100mm
DIBM2013	20" x 13"	330mm	120mm	490mm	445mm	100mm
DIBM2016	20" x 16"	400mm	165mm	490mm	445mm	100mm
DIBM2018	20" x 18"	450mm	195mm	490mm	445mm	100mm
DIBMCUST	XXXX	XXXX	Proportional	XXXX	XXXX	Proportional
DIBMCUSTXL	XXXX	XXXX	Proportional	XXXX	XXXX	Proportional

IGNITE BACK SUPPORT SHELL DIMENSIONS

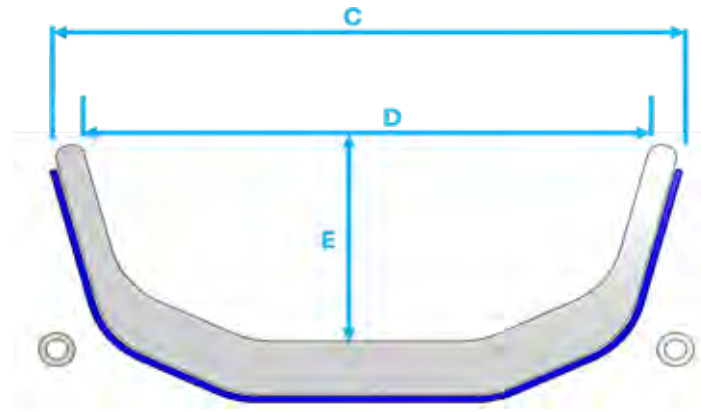
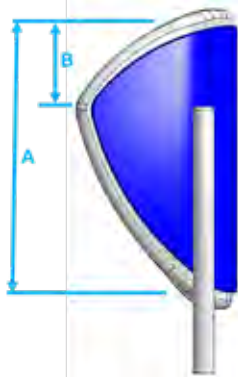

<i>CODE (QUICK-RELEASE)</i>	<i>SIZE (width x height)</i>	<i>A (Back Support shell height)</i>	<i>B (Centre of Lateral Posi)</i>	<i>C (Back Support O/A width)</i>	<i>D (between laterals)</i>	<i>E (Lateral depth)</i>
DEEP CONTOUR (ALUMINIUM)						
<i>DIBD1412</i>	<i>14" x 12"</i>	<i>300mm</i>	<i>120mm</i>	<i>340mm</i>	<i>295mm</i>	<i>130mm</i>
<i>DIBD1414</i>	<i>14" x 14"</i>	<i>350mm</i>	<i>135mm</i>	<i>340mm</i>	<i>295mm</i>	<i>130mm</i>
<i>DIBD1416</i>	<i>14" x 16"</i>	<i>400mm</i>	<i>170mm</i>	<i>340mm</i>	<i>295mm</i>	<i>130mm</i>
<i>DIBD1418</i>	<i>14" x 18"</i>	<i>450mm</i>	<i>195mm</i>	<i>340mm</i>	<i>295mm</i>	<i>130mm</i>
<i>DIBD1512</i>	<i>15" x 12"</i>	<i>300mm</i>	<i>120mm</i>	<i>360mm</i>	<i>315mm</i>	<i>130mm</i>
<i>DIBD1514</i>	<i>15" x 14"</i>	<i>350mm</i>	<i>135mm</i>	<i>360mm</i>	<i>315mm</i>	<i>130mm</i>
<i>DIBD1516</i>	<i>15" x 16"</i>	<i>400mm</i>	<i>170mm</i>	<i>360mm</i>	<i>315mm</i>	<i>130mm</i>
<i>DIBD1518</i>	<i>15" x 18"</i>	<i>450mm</i>	<i>195mm</i>	<i>360mm</i>	<i>315mm</i>	<i>130mm</i>
<i>DIBD1613</i>	<i>16" x 13"</i>	<i>330mm</i>	<i>140mm</i>	<i>390mm</i>	<i>345mm</i>	<i>150mm</i>
<i>DIBD1616</i>	<i>16" x 16"</i>	<i>400mm</i>	<i>155mm</i>	<i>390mm</i>	<i>345mm</i>	<i>150mm</i>
<i>DIBD1618</i>	<i>16" x 18"</i>	<i>450mm</i>	<i>195mm</i>	<i>390mm</i>	<i>345mm</i>	<i>150mm</i>
<i>DIBD1620</i>	<i>16" x 20"</i>	<i>500mm</i>	<i>230mm</i>	<i>390mm</i>	<i>345mm</i>	<i>150mm</i>
<i>DIBD1713</i>	<i>17" x 13"</i>	<i>330mm</i>	<i>140mm</i>	<i>415mm</i>	<i>370mm</i>	<i>150mm</i>
<i>DIBD1716</i>	<i>17" x 16"</i>	<i>400mm</i>	<i>155mm</i>	<i>415mm</i>	<i>370mm</i>	<i>150mm</i>
<i>DIBD1718</i>	<i>17" x 18"</i>	<i>450mm</i>	<i>195mm</i>	<i>415mm</i>	<i>370mm</i>	<i>150mm</i>
<i>DIBD1720</i>	<i>17" x 20"</i>	<i>500mm</i>	<i>230mm</i>	<i>415mm</i>	<i>370mm</i>	<i>150mm</i>
<i>DIBD1813</i>	<i>18" x 13"</i>	<i>330mm</i>	<i>140mm</i>	<i>440mm</i>	<i>395mm</i>	<i>150mm</i>
<i>DIBD1816</i>	<i>18" x 16"</i>	<i>400mm</i>	<i>155mm</i>	<i>440mm</i>	<i>395mm</i>	<i>150mm</i>
<i>DIBD1818</i>	<i>18" x 18"</i>	<i>450mm</i>	<i>195mm</i>	<i>440mm</i>	<i>395mm</i>	<i>150mm</i>
<i>DIBD1820</i>	<i>18" x 20"</i>	<i>500mm</i>	<i>230mm</i>	<i>440mm</i>	<i>395mm</i>	<i>150mm</i>
<i>DIBD2013</i>	<i>20" x 13"</i>	<i>330mm</i>	<i>140mm</i>	<i>490mm</i>	<i>445mm</i>	<i>150mm</i>
<i>DIBD2016</i>	<i>20" x 16"</i>	<i>400mm</i>	<i>155mm</i>	<i>490mm</i>	<i>445mm</i>	<i>150mm</i>
<i>DIBD2018</i>	<i>20" x 18"</i>	<i>450mm</i>	<i>195mm</i>	<i>490mm</i>	<i>445mm</i>	<i>150mm</i>
<i>DIBD2020</i>	<i>20" x 20"</i>	<i>500mm</i>	<i>230mm</i>	<i>490mm</i>	<i>445mm</i>	<i>150mm</i>
<i>DIBDCUST</i>	<i>XXXX</i>	<i>XXXX</i>	<i>Proportional</i>	<i>XXXX</i>	<i>XXXX</i>	<i>Proportional</i>
<i>DIBDCUSTXL</i>	<i>XXXX</i>	<i>XXXX</i>	<i>Proportional</i>	<i>XXXX</i>	<i>XXXX</i>	<i>Proportional</i>

IGNITE BACK SUPPORT SHELL DIMENSIONS

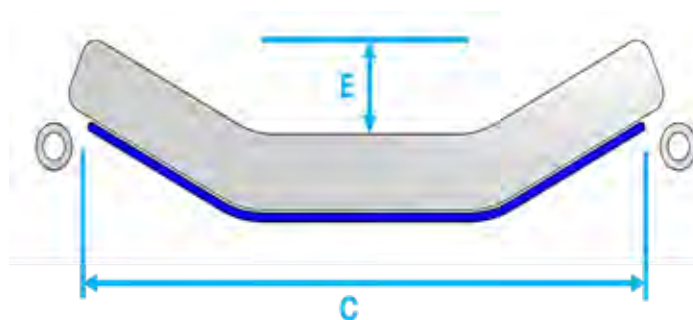

<i>CODE (QUICK-RELEASE)</i>	<i>SIZE (width x height)</i>	<i>A (Back Support shell height)</i>	<i>B (Centre of Lateral Posi)</i>	<i>C (Back Support O/A width)</i>	<i>D (between laterals)</i>	<i>E (Lateral depth)</i>
PRO ACTIVE CONTOUR (CARBON)						
<i>DPBA1407</i>	<i>14" x 07"</i>	<i>170mm</i>	-	<i>285mm</i>	-	<i>40mm</i>
<i>DPBA1409</i>	<i>14" x 09"</i>	<i>230mm</i>	-	<i>285mm</i>	-	<i>40mm</i>
<i>DPBA1412</i>	<i>14" x 12"</i>	<i>300mm</i>	-	<i>285mm</i>	-	<i>40mm</i>
<i>DPBA1507</i>	<i>15" x 07"</i>	<i>170mm</i>	-	<i>310mm</i>	-	<i>40mm</i>
<i>DPBA1509</i>	<i>15" x 09"</i>	<i>230mm</i>	-	<i>310mm</i>	-	<i>40mm</i>
<i>DPBA1512</i>	<i>15" x 12"</i>	<i>300mm</i>	-	<i>310mm</i>	-	<i>40mm</i>
<i>DPBA1608</i>	<i>16" x 08"</i>	<i>200mm</i>	-	<i>335mm</i>	-	<i>45mm</i>
<i>DPBA1610</i>	<i>16" x 10"</i>	<i>250mm</i>	-	<i>335mm</i>	-	<i>45mm</i>
<i>DPBA1613</i>	<i>16" x 13"</i>	<i>330mm</i>	-	<i>335mm</i>	-	<i>45mm</i>
<i>DPBA1708</i>	<i>17" x 08"</i>	<i>200mm</i>	-	<i>360mm</i>	-	<i>45mm</i>
<i>DPBA1710</i>	<i>17" x 10"</i>	<i>250mm</i>	-	<i>360mm</i>	-	<i>45mm</i>
<i>DPBA1713</i>	<i>17" x 13"</i>	<i>330mm</i>	-	<i>360mm</i>	-	<i>45mm</i>
<i>DPBA1808</i>	<i>18" x 08"</i>	<i>200mm</i>	-	<i>385mm</i>	-	<i>50mm</i>
<i>DPBA1810</i>	<i>18" x 10"</i>	<i>250mm</i>	-	<i>385mm</i>	-	<i>50mm</i>
<i>DPBA1813</i>	<i>18" x 13"</i>	<i>330mm</i>	-	<i>385mm</i>	-	<i>50mm</i>
<i>DPBA2008</i>	<i>20" x 08"</i>	<i>200mm</i>	-	<i>435mm</i>	-	<i>50mm</i>
<i>DPBA2010</i>	<i>20" x 10"</i>	<i>250mm</i>	-	<i>435mm</i>	-	<i>50mm</i>
<i>DPBA2013</i>	<i>20" x 13"</i>	<i>330mm</i>	-	<i>435mm</i>	-	<i>50mm</i>
<i>DPBACUST</i>	<i>XXXX</i>	<i>XXXX</i>	-	<i>XXXX</i>	<i>XXXX</i>	<i>60mm</i>
<i>DPBACUSTXL</i>	<i>XXXX</i>	<i>XXXX</i>	-	<i>XXXX</i>	<i>XXXX</i>	<i>60mm</i>

IGNITE BACK SUPPORT SHELL DIMENSIONS

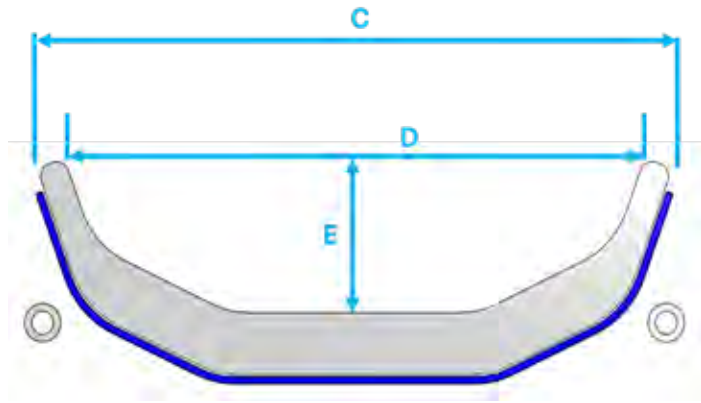
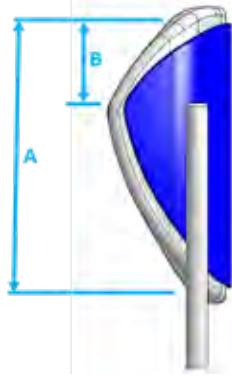

<i>CODE (QUICK-RELEASE)</i>	<i>SIZE (width x height)</i>	<i>A (Back Support shell height)</i>	<i>B (Centre of Lateral Posi)</i>	<i>C (Back Support O/A width)</i>	<i>D (between laterals)</i>	<i>E (Lateral depth)</i>
PRO MEDIUM CONTOUR (CARBON) • ADJUSTABLE BY 2"						
<i>DPBM1407</i>	<i>14" x 07"</i>	<i>170mm</i>	<i>80mm</i>	<i>340mm</i>	<i>295mm</i>	<i>85mm</i>
<i>DPBM1409</i>	<i>14" x 09"</i>	<i>230mm</i>	<i>90mm</i>	<i>340mm</i>	<i>295mm</i>	<i>85mm</i>
<i>DPBM1412</i>	<i>14" x 12"</i>	<i>300mm</i>	<i>115mm</i>	<i>340mm</i>	<i>295mm</i>	<i>85mm</i>
<i>DPBM1507</i>	<i>15" x 07"</i>	<i>170mm</i>	<i>80mm</i>	<i>360mm</i>	<i>315mm</i>	<i>85mm</i>
<i>DPBM1509</i>	<i>15" x 09"</i>	<i>230mm</i>	<i>90mm</i>	<i>360mm</i>	<i>315mm</i>	<i>85mm</i>
<i>DPBM1512</i>	<i>15" x 12"</i>	<i>300mm</i>	<i>115mm</i>	<i>360mm</i>	<i>315mm</i>	<i>85mm</i>
<i>DPBM1608</i>	<i>16" x 08"</i>	<i>200mm</i>	<i>90mm</i>	<i>390mm</i>	<i>345mm</i>	<i>100mm</i>
<i>DPBM1610</i>	<i>16" x 10"</i>	<i>250mm</i>	<i>96mm</i>	<i>390mm</i>	<i>345mm</i>	<i>100mm</i>
<i>DPBM1613</i>	<i>16" x 13"</i>	<i>330mm</i>	<i>120mm</i>	<i>390mm</i>	<i>345mm</i>	<i>100mm</i>
<i>DPBM1708</i>	<i>17" x 08"</i>	<i>200mm</i>	<i>90mm</i>	<i>415mm</i>	<i>370mm</i>	<i>100mm</i>
<i>DPBM1710</i>	<i>17" x 10"</i>	<i>250mm</i>	<i>96mm</i>	<i>415mm</i>	<i>370mm</i>	<i>100mm</i>
<i>DPBM1713</i>	<i>17" x 13"</i>	<i>330mm</i>	<i>120mm</i>	<i>415mm</i>	<i>370mm</i>	<i>100mm</i>
<i>DPBM1808</i>	<i>18" x 08"</i>	<i>200mm</i>	<i>90mm</i>	<i>440mm</i>	<i>395mm</i>	<i>100mm</i>
<i>DPBM1810</i>	<i>18" x 10"</i>	<i>250mm</i>	<i>96mm</i>	<i>440mm</i>	<i>395mm</i>	<i>100mm</i>
<i>DPBM1813</i>	<i>18" x 13"</i>	<i>330mm</i>	<i>120mm</i>	<i>440mm</i>	<i>395mm</i>	<i>100mm</i>
<i>DPBM2008</i>	<i>20" x 08"</i>	<i>200mm</i>	<i>90mm</i>	<i>490mm</i>	<i>445mm</i>	<i>100mm</i>
<i>DPBM2010</i>	<i>20" x 10"</i>	<i>250mm</i>	<i>96mm</i>	<i>490mm</i>	<i>445mm</i>	<i>100mm</i>
<i>DPBM2013</i>	<i>20" x 13"</i>	<i>330mm</i>	<i>120mm</i>	<i>490mm</i>	<i>445mm</i>	<i>100mm</i>
<i>DPBMCUST</i>	<i>XXXX</i>	<i>XXXX</i>	<i>ADJUSTABLE</i>	<i>XXXX</i>	<i>ADJUSTABLE</i>	<i>100mm</i>
<i>DPBMCUSTXL</i>	<i>XXXX</i>	<i>XXXX</i>	<i>ADJUSTABLE</i>	<i>XXXX</i>	<i>ADJUSTABLE</i>	<i>100mm</i>

IGNITE BACK SUPPORT SHELL DIMENSIONS

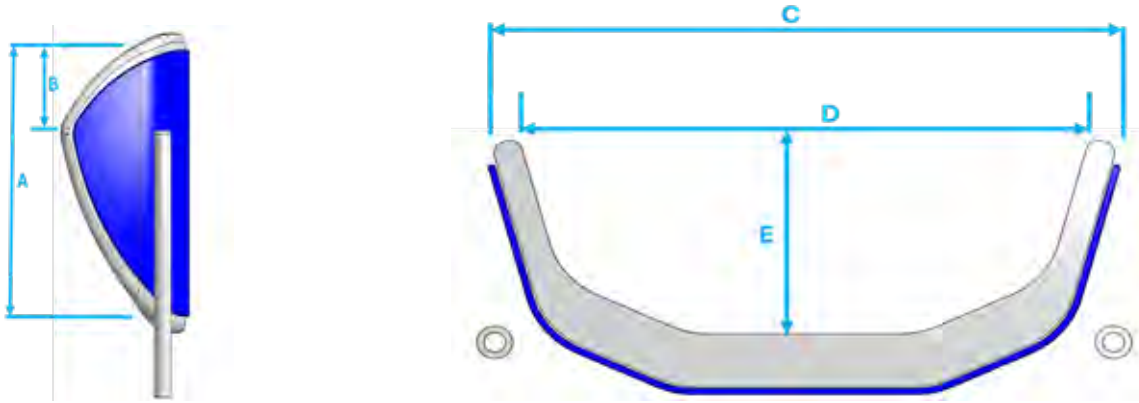

CODE (QUICK-RELEASE)	SIZE (width x height)	A (Back Support shell height)	B (Centre of Lateral Posi)	C (Back Support O/A width)	D (between laterals)	E (Lateral depth)
PRO DEEP CONTOUR (CARBON) *ADJUSTABLE BY 2"						
DPBD1409	14" x 09"	230mm	90mm	340mm	295mm	130mm
DPBD1412	14" x 12"	300mm	115mm	340mm	295mm	130mm
DPBD1509	15" x 09"	230mm	90mm	360mm	315mm	130mm
DPBD1512	15" x 12"	300mm	115mm	360mm	315mm	130mm
DPBD1610	16" x 10"	250mm	96mm	390mm	345mm	130mm
DPBD1613	16" x 13"	330mm	120mm	390mm	345mm	150mm
DPBD1710	17" x 10"	250mm	96mm	415mm	370mm	150mm
DPBD1713	17" x 13"	330mm	120mm	415mm	370mm	150mm
DPBD1810	18" x 10"	250mm	96mm	440mm	395mm	150mm
DPBD1813	18" x 13"	330mm	120mm	440mm	395mm	150mm
DPBD2010	20" x 10"	250mm	96mm	490mm	445mm	150mm
DPBD2013	20" x 13"	330mm	120mm	490mm	445mm	150mm
DPBDCUST	XXXX	XXXX	ADJUSTABLE	XXXX	ADJUSTABLE	150mm
DPBDCUSTXL	XXXX	XXXX	ADJUSTABLE	XXXX	ADJUSTABLE	150mm

Accessories

- To order an Outer Cover only for any Ignite Back Support item please add "OC" to end of the aluminium shell codes DIBA, DIBM and DIBD respectively. This includes if ordering for Pro and Fixed Hardware back support items.
- To order an Inner Cover only for any Ignite Back Support item please add "IC" to end of the aluminium shell codes DIBA, DIBM and DIBD respectively. This includes if ordering for Pro and Fixed Hardware back support options.

Spare Parts

- Shell and Pad only add "SP" to end of code
- To order a Foam and Cover only for any Ignite Back Support item please add "FC" to end of the aluminium shell codes DIBA, DIBM and DIBD respectively. This includes if ordering for Pro and Fixed Hardware back support options.

**IGNITE ACTIVE
(FIXED - ALUMINIUM)**



DIBAF1407	DIBAF1409	DIBAF1412	DIBAF1414	DIBAF1416	DIBAF1507	DIBAF1509	DIBAF1512
DIBAF1514	DIBAF1516	DIBAF1608	DIBAF1610	DIBAF1613	DIBAF1616	DIBAF1618	DIBAF1708
DIBAF1710	DIBAF1713	DIBAF1716	DIBAF1718	DIBAF1808	DIBAF1810	DIBAF1813	DIBAF1816
DIBAF1818	DIBAF2008	DIBAF2010	DIBAF2013	DIBAF2016	DIBAF2018	DIBAFFCUST	DIBAFFCUSTXL

• These Back Supports use the same spare covers as the Ignite quick- release options so use DIBAxxxxxOC

**IGNITE MEDIUM
(FIXED - ALUMINIUM)**



DIBMF1407	DIBMF1409	DIBMF1412	DIBMF1414	DIBMF1416	DIBMF1507	DIBMF1509	DIBMF1512
DIBMF1514	DIBMF1516	DIBMF1608	DIBMF1610	DIBMF1613	DIBMF1616	DIBMF1618	DIBMF1708
DIBMF1710	DIBMF1713	DIBMF1716	DIBMF1718	DIBMF1808	DIBMF1810	DIBMF1813	DIBMF1816
DIBMF1818	DIBMF2008	DIBMF2010	DIBMF2013	DIBMF2016	DIBMF2018	DIBMFFCUST	DIBMFFCUSTXL

• These Back Supports use the same spare covers as the Ignite quick- release options so use DIBMxxxxxOC

**IGNITE DEEP
(FIXED - ALUMINIUM)**



DIBDF1412	DIBDF1414	DIBDF1416	DIBDF1418	DIBDF1512	DIBDF1514	DIBDF1516	DIBDF1518
DIBDF1613	DIBDF1616	DIBDF1618	DIBDF1620	DIBDF1713	DIBDF1716	DIBDF1718	DIBDF1720
DIBDF1813	DIBDF1816	DIBDF1818	DIBDF1820	DIBDF2013	DIBDF2016	DIBDF2018	DIBDF2020
DIBDFCUST	DIBDFCUSTXL						

• These Back Supports use the same spare covers as the Ignite quick- release options so use DIBDxxxxxOC

**IGNITE PRO ACTIVE
(FIXED - CARBON)**



DPBAF1407	DPBAF1409	DPBAF1412	DPBAF1507	DPBAF1509	DPBAF1512	DPBAF1608	DPBAF1610
DPBAF1613	DPBAF1708	DPBAF1710	DPBAF1713	DPBAF1808	DPBAF1810	DPBAF1813	DPBAF2008
DPBAF2010	DPBAF2013	DPBAFCUST	DPBAFCUSTXL				

• These Back Supports use the same spare covers as the Ignite quick- release options so use DIBAxkxkOC

**IGNITE PRO MEDIUM
(FIXED - CARBON)**



DPBMF1407	DPBMF1409	DPBMF1412	DPBMF1507	DPBMF1509	DPBMF1512	DPBMF1608	DPBMF1610
DPBMF1613	DPBMF1708	DPBMF1710	DPBMF1713	DPBMF1808	DPBMF1810	DPBMF1813	DPBMF2008
DPBMF2010	DPBMF2013	DPBMFCUST	DPBMFCUSTXL				

• These Back Supports use the same spare covers as the Ignite quick- release options so use DIBMkxkxOC

**IGNITE PRO DEEP
(FIXED - CARBON)**



DPBDF1409	DPBDF1412	DPBDF1509	DPBDF1512	DPBDF1610	DPBDF1613	DPBDF1710	DPBDF1713
DPBDF1810	DPBDF1813	DPBDF2010	DPBDF2013	DPBDFCUST	DPBDFCUSTXL		

• These Back Supports use the same spare covers as the Ignite quick- release options so use DIBDkxkxOC

Dreamline Contour Back Support



The Dreamline Contour Back Support has a one piece shell with a deep contour profile. The laterals are positioned lower to enable clearance for unrestricted arm movement. Multiple hole positions for easy mounting of Head Supports, harnesses etc.

INCLUDED

FIXED

- Back Support Shell with L-brackets and clamps
- Foam Inner
- FLO2™ Outer Cover
- Lumbar Pad
- Lateral Stability Wedges x 2

QUICK-RELEASE

- Back Support Shell with L-brackets and pins
- Foam Inner
- FLO2™ Outer Cover
- Lumbar Pad
- Lateral Stability Wedges x 2

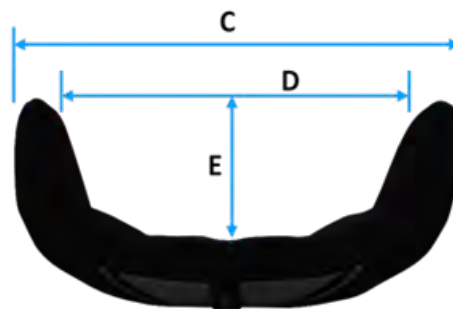

Back Support WIDTH	8" (203mm)	10" (254mm)	12" (305mm)	14" (355mm)	16" (406mm)	18" (457mm)	20" (508mm)
C	180mm	230mm	280mm	330mm	380mm	430mm	480mm
D	140mm	190mm	230mm	280mm	330mm	380mm	430mm
E	110mm	115mm	120mm	125mm	140mm	150mm	155mm

**DREAMLINE CONTOUR
BACK SUPPORT
(QUICK-RELEASE)**



DCB0810	DCB0812	DCB1012	DCB1014	DCB1214	DCB1216	DCB1218	DIBDF1518
DCB1414	DCB1416	DCB1418	DCB1420	DCB1616	DCB1618	DCB1620	DIBDF1720
DCB1622	DCB1816	DCB1818	DCB1820	DCB1822	DCB2018	DCB2020	DIBDF2020
DCB2022	DCBCUST	DCBCUSTXL					

*Outer Cover only add "OC" to end of code • Inner Cover only add "IC" to end of code
Shell and Pad only add "SP" to end of code • Foam and Cover only add "FC" to end of code*

**DREAMLINE CONTOUR
BACK SUPPORT (FIXED)**



DCBF0810	DCBF0812	DCBF1012	DCBF1014	DCBF1214	DCBF1216	DCBF1218	DIBDF1518
DCBF1414	DCBF1416	DCBF1418	DCBF1420	DCBF1616	DCBF1618	DCBF1620	DIBDF1720
DCBF1622	DCBF1816	DCBF1818	DCBF1820	DCBF1822	DCBF2018	DCBF2020	DIBDF2020
DCBF2022	DCBFCUST	DCBFCUSTXL					

• Uses the same outer and inner covers as the Contour quick-release Back Support, so add OC, IC, or FC to codes above if required.

Dreamline Support Back Support Series



- Back Support Reinforcement plates ensure robust lateral and Back Support bracketry attachment.*
- *Fitted to all Dreamline Support Back Supports including a 16" height and up.*

The Dreamline Support Series is a supportive rectangular Back Support to which laterals, Head Supports, harnesses etc can be attached. The Back Support has upgrade options to accommodate advanced asymmetrical postures.

Back Support pad options in the Dreamline Support series

SUPPORT



With the cover removed showing the unique Bubble Contour slim comfortable pad.

Add the BAC system for asymmetrical contours.

S3



With the cover removed exposing the soft deep foam enabling immersion, great for low-tone users.

Add the BAC system for asymmetrical contours.

STX



Contains multiple Visco-elastic Sunmate foam pillows which can be rearranged for asymmetrical postures.

Dreamline Support Back Support Series *cont.*



INCLUDED IN THE KIT

FIXED

- Back Support Shell with L-brackets and clamps
- Foam Inner
- FLO2™ Outer Cover
- Lumbar Pad
- Lateral Stability Wedges x 2

QUICK-RELEASE

- Back Support Shell with L-brackets and pins
- Foam Inner
- FLO2™ Outer Cover
- Lumbar Pad
- Lateral Stability Wedges x 2

SUPPORT SERIES BACK SUPPORT SHELL WIDTHS

WHEELCHAIR WIDTH	8" (203mm)	10" (254mm)	12" (305mm)	14" (355mm)	16" (406mm)	18" (457mm)	20" (508mm)
ACTUAL SHELL WIDTH	150mm	190mm	235mm	285mm	340mm	380mm	425mm

- Note: The Dreamline Support Back Support Series (Support, S3, STX) are designed to fit between the wheelchair Back Support canes.
- Please note the foam does overhang the shell. This is approximately 15mm on each side and on the bottom and by 25mm on the top.

Dreamline STX Back Support Pillow Layout



The Dreamline STX Back Support has a single layer of Sunmate foam cluster pillows with their quantities and layout pattern shown below.

Each Back Support also includes an extra pack of 4 Cluster pillows.

0810

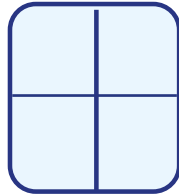

0812

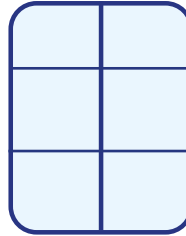

1620 / 1820

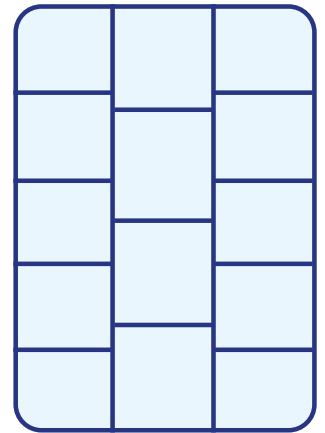

1012 / 1014 /
1214 / 1414 /
1416

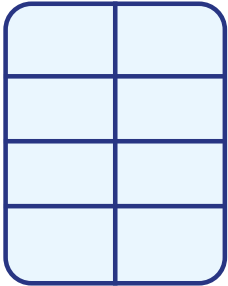

4 4

1616

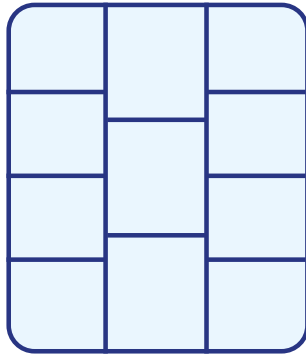

4 3 4

1618 / 1818

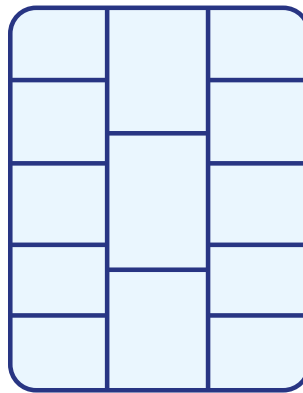

5 3 5

1622 / 1822

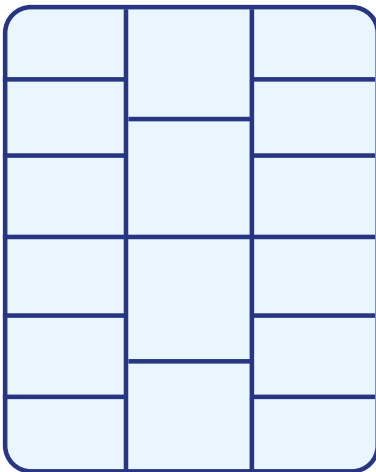

6 4 6

2020

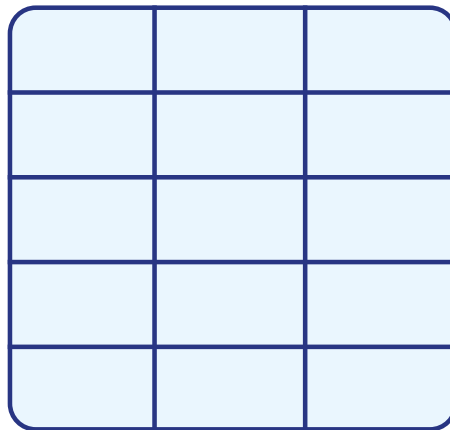

5 5 5

2022

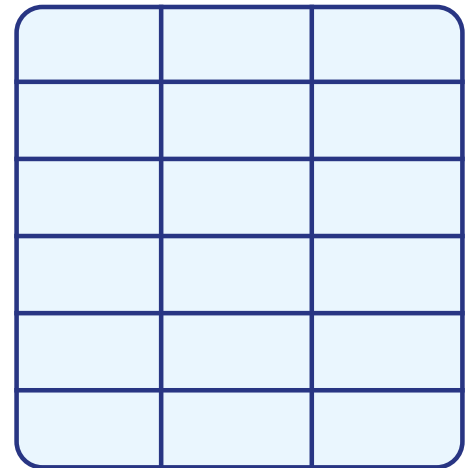

6 6 6

BAC System

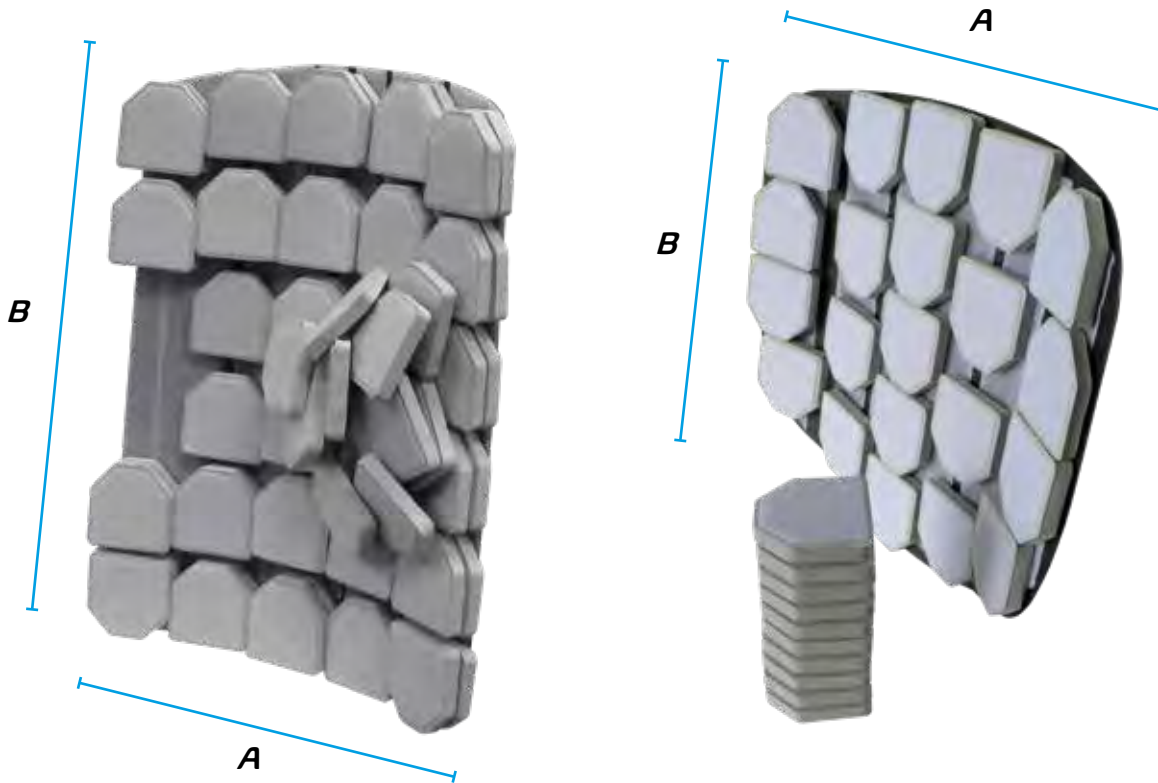

The BAC (Back Support Advanced Contour) System adds the capability to any Ignite, Support, S3 or STX Back Support to accommodate asymmetrical postures. The rigid BAC Shell easily inserts or removes from behind the Back Support foam inner inside the Back Support cover as a cassette to which the pads can be reconfigured to suit the user.

BAC SYSTEM

(Back Support Advanced Contour system for Support Back Supports)

DBACSB0810	DBACSB0812	DBACSB1012	DBACSB1014	DBACSB1214	DBACSB1216	DBACSB1218
DBACSB1414	DBACSB1416	DBACSB1418	DBACSB1420	DBACSB1616	DBACSB1618	DBACSB1620
DBACSB1622	DBACSB1816	DBACSB1818	DBACSB1820	DBACSB1822	DBACSB2018	DBACSB2020
DBACSB2022	DBACSBUCUST	DBACSBUCUSTXL				

BAC SYSTEM FOR IGNITE BACK SUPPORTS

DBACIB1407	DBACIB1409	DBACIB1412	DBACIB1414	DBACIB1416	DBACIB1418	DBACIB1507
DBACIB1509	DBACIB1512	DBACIB1514	DBACIB1516	DBACIB1518	DBACIB1608	DBACIB1610
DBACIB1613	DBACIB1616	DBACIB1618	DBACIB1620	DBACIB1708	DBACIB1710	DBACIB1713
DBACIB1716	DBACIB1718	DBACIB1720	DBACIB1808	DBACIB1810	DBACIB1813	DBACIB1816
DBACIB1818	DBACIB1820	DBACIB2008	DBACIB2010	DBACIB2013	DBACIB2016	DBACIB2018
DBACIB2020	DBACIBUCUST	DBACIBUCUSTXL				



BAC PADS LAYOUT (SUPPORT SERIES BACK SUPPORTS)

<i>CODE</i>	<i>Back Support SIZE</i>	<i>A (# OF PADS)</i>	<i>B (# OF PADS)</i>	<i># OF LAYERS</i>
<i>DBACSB0810</i>	<i>8" x 10"</i>	<i>3</i>	<i>5</i>	<i>2</i>
<i>DBACSB0812</i>	<i>8" x 12"</i>	<i>3</i>	<i>5</i>	<i>2</i>
<i>DBACSB1012</i>	<i>10" x 12"</i>	<i>3</i>	<i>5</i>	<i>2</i>
<i>DBACSB1014</i>	<i>10" x 14"</i>	<i>3</i>	<i>6</i>	<i>2</i>
<i>DBACSB1214</i>	<i>12" x 14"</i>	<i>4</i>	<i>6</i>	<i>2</i>
<i>DBACSB1216</i>	<i>12" x 16"</i>	<i>4</i>	<i>6</i>	<i>2</i>
<i>DBACSB1218</i>	<i>12" x 18"</i>	<i>4</i>	<i>7</i>	<i>2</i>
<i>DBACSB1414</i>	<i>14" x 14"</i>	<i>4</i>	<i>5</i>	<i>2</i>
<i>DBACSB1416</i>	<i>14" x 16"</i>	<i>4</i>	<i>5</i>	<i>2</i>
<i>DBACSB1418</i>	<i>14" x 18"</i>	<i>4</i>	<i>6</i>	<i>2</i>
<i>DBACSB1420</i>	<i>14" x 20"</i>	<i>4</i>	<i>7</i>	<i>2</i>
<i>DBACSB1616</i>	<i>16" x 16"</i>	<i>5</i>	<i>5</i>	<i>2</i>
<i>DBACSB1618</i>	<i>16" x 18"</i>	<i>5</i>	<i>6</i>	<i>2</i>
<i>DBACSB1620</i>	<i>16" x 20"</i>	<i>5</i>	<i>7</i>	<i>2</i>
<i>DBACSB1622</i>	<i>16" x 22"</i>	<i>5</i>	<i>7</i>	<i>2</i>
<i>DBACSB1816</i>	<i>18" x 16"</i>	<i>5</i>	<i>5</i>	<i>2</i>
<i>DBACSB1818</i>	<i>18" x 18"</i>	<i>5</i>	<i>6</i>	<i>2</i>
<i>DBACSB1820</i>	<i>18" x 20"</i>	<i>5</i>	<i>7</i>	<i>2</i>
<i>DBACSB1822</i>	<i>18" x 22"</i>	<i>5</i>	<i>7</i>	<i>2</i>
<i>DBACSB2018</i>	<i>20" x 18"</i>	<i>6</i>	<i>6</i>	<i>2</i>
<i>DBACSB2020</i>	<i>20" x 20"</i>	<i>6</i>	<i>7</i>	<i>2</i>
<i>DBACSB2022</i>	<i>20" x 22"</i>	<i>6</i>	<i>7</i>	<i>2</i>
<i>DBACSB CUST</i>	<i>XXXX</i>	<i>X</i>	<i>X</i>	<i>X</i>
<i>DBACSB CUSTXL</i>	<i>XXXX</i>	<i>X</i>	<i>X</i>	<i>X</i>

The BAC System back plate for the Support Back Support series is 30mm narrower than the Back Support shell by 30mm to allow for the lateral brackets to have unrestricted inwards adjustment.

BAC PADS LAYOUT (IGNITE SERIES BACK SUPPORTS)

CODE	Back Support SIZE	A (# OF PADS)	B (# OF PADS)	# OF LAYERS
DBACIB1407	14" x 07"	4	3	1
DBACIB1409	14" x 09"	4	3	1
DBACIB1412	14" x 12"	4	4	1
DBACIB1414	14" x 14"	4	5	1
DBACIB1416	14" x 16"	4	5	1
DBACIB1418	14" x 18"	4	6	1
DBACIB1507	15" x 07"	4	3	1
DBACIB1509	15" x 09"	4	3	1
DBACIB1512	15" x 12"	4	4	1
DBACIB1514	15" x 14"	4	5	1
DBACIB1516	15" x 16"	4	5	1
DBACIB1518	15" x 18"	4	7	1
DBACIB1608	16" x 08"	5	3	1
DBACIB1610	16" x 10"	5	3	1
DBACIB1613	16" x 13"	5	5	1
DBACIB1616	16" x 16"	5	5	1
DBACIB1618	16" x 18"	5	6	1
DBACIB1620	16" x 20"	5	7	1
DBACIB1708	17" x 08"	5	3	1
DBACIB1710	17" x 10"	5	3	1
DBACIB1713	17" x 13"	5	5	1
DBACIB1716	17" x 16"	5	5	1
DBACIB1718	17" x 18"	5	6	1
DBACIB1720	17" x 20"	5	7	1
DBACIB1808	18" x 08"	5	3	1
DBACIB1810	18" x 10"	5	3	1
DBACIB1813	18" x 13"	5	5	1
DBACIB1816	18" x 16"	5	5	1
DBACIB1818	18" x 18"	5	6	1
DBACIB1820	18" x 20"	5	7	1
DBACIB2008	20" x 08"	6	3	1
DBACIB2010	20" x 10"	6	3	1
DBACIB2013	20" x 13"	6	5	1
DBACIB2016	20" x 16"	6	5	1
DBACIB2018	20" x 18"	6	6	1
DBACIB2020	20" x 20"	6	7	1

Each BAC System also includes an extra pack of 10 BAC pads.

**DREAMLINE SUPPORT
BACK SUPPORT -
QUICK-RELEASE**



<i>DSB0810</i>	<i>DSB0812</i>	<i>DSB1012</i>	<i>DSB1014</i>	<i>DSB1214</i>	<i>DSB1216</i>	<i>DSB1218</i>	<i>DSB1414</i>
<i>DSB1416</i>	<i>DSB1418</i>	<i>DSB1420</i>	<i>DSB1616</i>	<i>DSB1618</i>	<i>DSB1620</i>	<i>DSB1622</i>	<i>DSB1816</i>
<i>DSB1818</i>	<i>DSB1820</i>	<i>DSB1822</i>	<i>DSB2018</i>	<i>DSB2020</i>	<i>DSB2022</i>	<i>DSBCUST</i>	<i>DSBCUSTXL</i>

*Outer Cover only add "OC" to end of code • Inner Cover only add "IC" to end of code
Shell and Pad only add "SP" to end of code • Foam Inner and Outer Cover only add "FC" to the end of code*

**DREAMLINE SUPPORT
BACK SUPPORT -
FIXED**



<i>DSBF0810</i>	<i>DSBF0812</i>	<i>DSBF1012</i>	<i>DSBF1014</i>	<i>DSBF1214</i>	<i>DSBF1216</i>	<i>DSBF1218</i>	<i>DSBF1414</i>
<i>DSBF1416</i>	<i>DSBF1418</i>	<i>DSBF1420</i>	<i>DSBF1616</i>	<i>DSBF1618</i>	<i>DSBF1620</i>	<i>DSBF1622</i>	<i>DSBF1816</i>
<i>DSBF1818</i>	<i>DSBF1820</i>	<i>DSBF1822</i>	<i>DSBF2018</i>	<i>DSBF2020</i>	<i>DSBF2022</i>	<i>DSBFCUST</i>	<i>DSBFCUSTXL</i>

• Use the same outer and inner covers as the Support quick-release Back Support

**DREAMLINE S3
BACK SUPPORT -
QUICK-RELEASE**



<i>D3B0810</i>	<i>D3B0812</i>	<i>D3B1012</i>	<i>D3B1014</i>	<i>D3B1214</i>	<i>D3B1216</i>	<i>D3B1218</i>	<i>D3B1414</i>
<i>D3B1416</i>	<i>D3B1418</i>	<i>D3B1420</i>	<i>D3B1616</i>	<i>D3B1618</i>	<i>D3B1620</i>	<i>D3B1622</i>	<i>D3B1816</i>
<i>D3B1818</i>	<i>D3B1820</i>	<i>D3B1822</i>	<i>D3B2018</i>	<i>D3B2020</i>	<i>D3B2022</i>	<i>D3BCUST</i>	<i>D3BCUSTXL</i>

*Outer Cover only add "OC" to end of code • Inner Cover only add "IC" to end of code
Shell and Pad only add "SP" to end of code • Foam Inner and Outer Cover only add "FC" to the end of code*

**DREAMLINE S3
BACK SUPPORT -
FIXED**



D3BF0810	D3BF0812	D3BF1012	D3BF1014	D3BF1214	D3BF1216	D3BF1218	D3BF1414
D3BF1416	D3BF1418	D3BF1420	D3BF1616	D3BF1618	D3BF1620	D3BF1622	D3BF1816
D3BF1818	D3BF1820	D3BF1822	D3BF2018	D3BF2020	D3BF2022	D3BFCUST	D3BFCUSTXL

• Use the same outer and inner covers as the S3 quick-release Back Support

**DREAMLINE STX
BACK SUPPORT -
QUICK-RELEASE**



DXB0810	DXB0812	DXB1012	DXB1014	DXB1214	DXB1216	DXB1218	DXB1414
DXB1416	DXB1418	DXB1420	DXB1616	DXB1618	DXB1620	DXB1622	DXB1816
DXB1818	DXB1820	DXB1822	DXB2018	DXB2020	DXB2022	DXBCUST	DXBCUSTXL

Outer Cover only add "OC" to end of code • Inner Cover only add "IC" to end of code
Shell and Pad only add "SP" to end of code • Foam Inner and Outer Cover only add "FC" to the end of code

**DREAMLINE STX
BACK SUPPORT -
FIXED**



DXBF0810	DXBF0812	DXBF1012	DXBF1014	DXBF1214	DXBF1216	DXBF1218	DXBF1414
DXBF1416	DXBF1418	DXBF1420	DXBF1616	DXBF1618	DXBF1620	DXBF1622	DXBF1816
DXBF1818	DXBF1820	DXBF1822	DXBF2018	DXBF2020	DXBF2022	DXBFCUST	DXBFCUSTXL

• Use the same outer and inner covers as the STX quick-release Back Support

Back Support Accessories



Back Support L-Bracket	W(Width Adj.)	H (Height Adj.)	T (Tilt)	WB (Actual Bracket Width)	DB(Actual Bracket Depth)	HB(Actual Bracket Height)
2-Point Back Support Standard L-Bracket	3" Overall - from 1" narrower to 2" wider	Full backrest Slot Range	+/- 30°	98mm/3.86"	95mm/3.74"	103mm/4.05"
Back Support 4-point Upgrade L-Bracket	3" Overall - from 1" narrower to 2" wider	Full backrest Slot Range	+/- 30°	98mm/3.86"	95mm/3.74"	50mm/1.97"
Compact (Ignite) Standard L-Bracket	3" Overall - from 1" narrower to 2" wider	Full backrest Slot Range	+/- 30°	88mm/3.46"	82mm/3.23"	65mm/2.56"
Compact (Ignite) Short L-Bracket	3" Overall - from 1" narrower to 2" wider	Full backrest Slot Range	+/- 30°	88mm/3.46"	47mm/1.85"	65mm/2.56"



Compact Hardware is used on the Support and Contour Back Supports when they have a height of 14" or lower, on all Ignite Aluminium shell except for sizes 1816,1818,2013,2016,2018 and 2020, and on all Ignite Carbon shells.

Back Support Accessories cont.

**COMPACT Q/R
CLAMPS**



*DBU2CPQRCLAMPKIT**

STD Q/R CLAMPS



DBU2QRCLAMPKIT

**4-POINT CLAMP
KIT**



DBU2QRCLAMPKIT4PT

**BACK SUPPORT
Q/R BKTS**



DBU2COM2P

**COMPACT
BACK SUPPORT
Q/R BKTS**



DBU2CPCOM2P

**4-POINT
UPGRADE KIT**



DBU2QR4PTKIT

**BACK SUPPORT
L-BKT 2 PIN**



DBU2LBKTDUAL

**BACK SUPPORT
L-BKT 1 PIN**



DBU2LBKTSING

**COMPACT
L-BKT 2 PIN**



DBU2LBKTCPDUAL

Back Support Accessories *cont.*

**4-POINT BACK
BKTS**



DBU2QRCOM4P

**SADDLEBACK
FIXED BACK
SUPPORT BKTS**



DBSFAS

**SADDLEBACK
FIXED BACK
SUPPORT BKTS - SHORT**



DBSFAS

**BACK SUPPORT
FIXED BKTS**



DBU2FA

**COMPACT
BACK SUPPORT
FIXED BKTS**



DBCMPFA

**IGNITE BACK
SUPPORT L-BRACKET
- SHORT**



DIBLBS

Back Support Accessories *cont.*

**WIDTH/DEPTH
REDUCTION KIT**



DBWRK

**IGNITE BACK SUPPORT
OFFSET PLATES**



DBCMPOSP

**CORPUS
INTERFACE PLATE**



CDBIFP

**LUMBAR KIT
COMPLETE**



DBMLTKIT

LUMBAR PAD



DBLP

**LATERAL
STABILITY WEDGE**



DBLW

**SUNMATE
CLUSTER PACK**



DCSFB46

**BAC PADS
-PACK OF 10**



DBACPADS10

Back Support Accessories cont.

MODESTY PANEL

(FOR IGNITE Back Supports)

CODE	FITS BACK SUPPORT SIZE	ACTUAL WIDTH
DBMP12	12"	155mm (6")
DBMP14	14"	205mm (8")
DBMP15	15"	230mm (9")
DBMP16	16"	255mm (10")
DBMP17	17"	280mm (11")
DBMP18	18"	305mm (12")
DBMP19	19"	330mm (13")
DBMP20	20"	355mm (14")
DBMPCUST	Custom	Custom



SIDEWINDER SUSPENSION KIT

DBSWSS

**SIDEWINDER SUSPENSION
BOTTOM OUTER SWING-ARM
ONLY (EXCLUDES FASTENERS
AND PINS)**

DBSWSSBOA



**SIDEWINDER
SPARE DAMPERS
SOFT (BLUE)**



DBSWSDS

**SIDEWINDER
SPARE DAMPERS
FIRM (ORANGE)**



DBSWSDF

**SIDEWINDER
SPARE DAMPERS
EXTRA FIRM (RED)**



DBSWSDEF

Back Support Accessories cont.

DREAMLINE SUPPORT BACK SUPPORT GROWTH KIT



Order the growth kit extension plate (DSBGK) and then choose your new size foam and cover (Add FC to end of the Back Support Code)

GROWTH KIT UPGRADE MODIFICATION FOR SUP- PORT BACK SUPPORT

Only Available on Support or S3 Back. Not Suitable for STX Back.



DSBGKU12	DSBGKU14	DSBGKU16	DSBGKU18	DSBGKU20	DSBGKUCUST
----------	----------	----------	----------	----------	------------

DREAMLINE BAC GROWTH KIT



DBACGK12	DBACGK14	DBACGK16	DBACGK18	DBACGK20	DBACGKUCUST	DBACGKUCUSTXL
----------	----------	----------	----------	----------	-------------	---------------

Back Support Modifications

EXTRA THICKNESS MOD

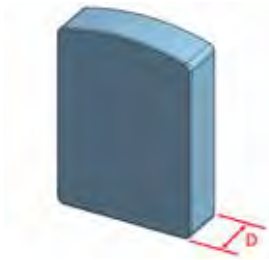

DBMODEF

T-MOD (SUPPORT BACK SUPPORT SERIES)

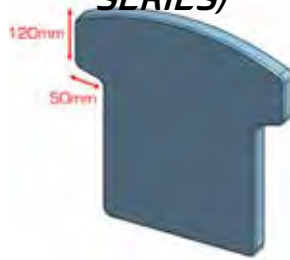

DBMODT

T-MOD (FOR BAC SYSTEM)

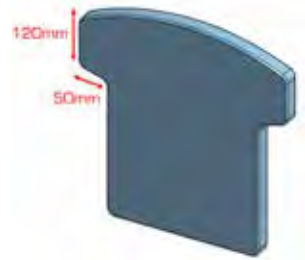

DBACMODT

• Includes shell extensions, new foam and cover.

GEL IN SPINAL REGION MOD

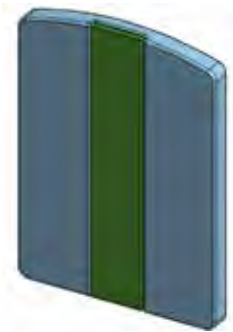

DBMODGSI

EXTRA SUNMATE FOAM OVERLAY MOD



DBMODSFO

DARTEX FABRIC SMOOTH MOD

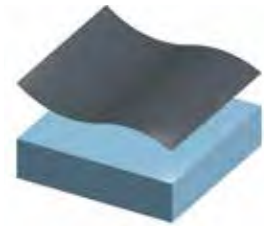

DBMODCPU

CUSTOM FABRIC MOD (OTHER)

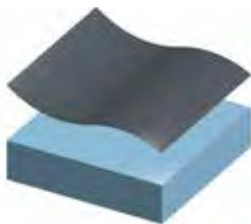

DBMODCF

BIANGULAR BACK SUPPORT MOD



DBMODBI

FIRM FOAM MOD



DBMODFF

Back Support Modifications *cont.*

COLOUR MOD
- RED



DBMODRED

COLOUR MOD
- BLUE



DBMODBLU

COLOUR MOD
- ORANGE



DBMODORA

COLOUR MOD
- GREEN



DBMODGRE

COLOUR MOD
- PURPLE



DBMODPUR

COLOUR MOD
- YELLOW



DBMODYEL

COLOUR MOD
- SILVER



DBMODSIL

COLOUR MOD
- PINK



DBMODPIN

Corpus Back Support Pads



<i>SKUs Size</i>	<i>Fits Permobil heights</i>	<i>Actual measurements</i>
1420, 1421, 1422	20", 21", 22"	1416, 1417, 1418
1423, 1424, 1425	23" 24", 25"	1419, 1420, 1421
1426, 1427, 1428	26", 27", 28"	1422, 1423, 1424
1620, 1621, 1622	20", 21", 22"	1616, 1617, 1618
1623, 1624, 1625	23", 24", 25"	1619, 1620, 1621
1626, 1627, 1628	26", 27", 28"	1622, 1623, 1624
1820, 1821, 1822	20", 21", 22"	1816, 1817, 1818
1823, 1824, 1825	23" 24", 25"	1819, 1820, 1821
1826, 1827, 1828	26", 27", 28"	1822, 1823, 1824
2020, 2021, 2022	20", 21", 22"	2016, 2017, 2018
2023, 2024, 2025	23" 24", 25"	2019, 2020, 2021
2026, 2027, 2028	26", 27", 28"	2022, 2023, 2024
2220, 2221, 2222	20", 21", 22"	2216, 2217, 2218
2223, 2224, 2225	23" 24", 25"	2219, 2220, 2221
2226, 2227, 2228	26", 27", 28"	2222, 2223, 2224

**CORPUS DREAMLINE
SUPPORT BACK SUPPORT**

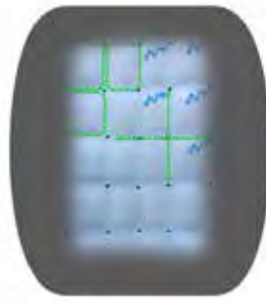

<i>CDSB1420FC</i>	<i>CDSB1421FC</i>	<i>CDSB1422FC</i>	<i>CDSB1423FC</i>	<i>CDSB1424FC</i>	<i>CDSB1425FC</i>	<i>CDSB1426FC</i>
<i>CDSB1427FC</i>	<i>CDSB1428FC</i>	<i>CDSB1620FC</i>	<i>CDSB1621FC</i>	<i>CDSB1622FC</i>	<i>CDSB1623FC</i>	<i>CDSB1624FC</i>
<i>CDSB1625FC</i>	<i>CDSB1626FC</i>	<i>CDSB1627FC</i>	<i>CDSB1628FC</i>	<i>CDSB1820FC</i>	<i>CDSB1821FC</i>	<i>CDSB1822FC</i>
<i>CDSB1823FC</i>	<i>CDSB1824FC</i>	<i>CDSB1825FC</i>	<i>CDSB1826FC</i>	<i>CDSB1827FC</i>	<i>CDSB1828FC</i>	<i>CDSB2020FC</i>
<i>CDSB2021FC</i>	<i>CDSB2022FC</i>	<i>CDSB2023FC</i>	<i>CDSB2024FC</i>	<i>CDSB2025FC</i>	<i>CDSB2026FC</i>	<i>CDSB2027FC</i>
<i>CDSB2028FC</i>	<i>CDSB2220FC</i>	<i>CDSB2221FC</i>	<i>CDSB2222FC</i>	<i>CDSB2223FC</i>	<i>CDSB2224FC</i>	<i>CDSB2225FC</i>
<i>CDSB2226FC</i>	<i>CDSB2227FC</i>	<i>CDSB2228FC</i>	<i>Replace "FC" with "OC" for spare outer cover</i>			

**CORPUS DREAMLINE
S3 BACK SUPPORT**



<i>CD3B1420FC</i>	<i>CD3B1421FC</i>	<i>CD3B1422FC</i>	<i>CD3B1423FC</i>	<i>CD3B1424FC</i>	<i>CD3B1425FC</i>	<i>CD3B1426FC</i>
<i>CD3B1427FC</i>	<i>CD3B1428FC</i>	<i>CD3B1620FC</i>	<i>CD3B1621FC</i>	<i>CD3B1622FC</i>	<i>CD3B1623FC</i>	<i>CD3B1624FC</i>
<i>CD3B1625FC</i>	<i>CD3B1626FC</i>	<i>CD3B1627FC</i>	<i>CD3B1628FC</i>	<i>CD3B1820FC</i>	<i>CD3B1821FC</i>	<i>CD3B1822FC</i>
<i>CD3B1823FC</i>	<i>CD3B1824FC</i>	<i>CD3B1825FC</i>	<i>CD3B1826FC</i>	<i>CD3B1827FC</i>	<i>CD3B1828FC</i>	<i>CD3B2020FC</i>
<i>CD3B2021FC</i>	<i>CD3B2022FC</i>	<i>CD3B2023FC</i>	<i>CD3B2024FC</i>	<i>CD3B2025FC</i>	<i>CD3B2026FC</i>	<i>CD3B2027FC</i>
<i>CD3B2028FC</i>	<i>CD3B2220FC</i>	<i>CD3B2221FC</i>	<i>CD3B2222FC</i>	<i>CD3B2223FC</i>	<i>CD3B2224FC</i>	<i>CD3B2225FC</i>
<i>CD3B2226FC</i>	<i>CD3B2227FC</i>	<i>CD3B2228FC</i>	<i>Replace "FC" with "OC" for spare outer cover</i>			

**CORPUS DREAMLINE
STX BACK SUPPORT**



<i>CDXB1420FC</i>	<i>CDXB1421FC</i>	<i>CDXB1422FC</i>	<i>CDXB1423FC</i>	<i>CDXB1424FC</i>	<i>CDXB1425FC</i>	<i>CDXB1426FC</i>
<i>CDXB1427FC</i>	<i>CDXB1428FC</i>	<i>CDXB1620FC</i>	<i>CDXB1621FC</i>	<i>CDXB1622FC</i>	<i>CDXB1623FC</i>	<i>CDXB1624FC</i>
<i>CDXB1625FC</i>	<i>CDXB1626FC</i>	<i>CDXB1627FC</i>	<i>CDXB1628FC</i>	<i>CDXB1820FC</i>	<i>CDXB1821FC</i>	<i>CDXB1822FC</i>
<i>CDXB1823FC</i>	<i>CDXB1824FC</i>	<i>CDXB1825FC</i>	<i>CDXB1826FC</i>	<i>CDXB1827FC</i>	<i>CDXB1828FC</i>	<i>CDXB2020FC</i>
<i>CDXB2021FC</i>	<i>CDXB2022FC</i>	<i>CDXB2023FC</i>	<i>CDXB2024FC</i>	<i>CDXB2025FC</i>	<i>CDXB2026FC</i>	<i>CDXB2027FC</i>
<i>CDXB2028FC</i>	<i>CDXB2220FC</i>	<i>CDXB2221FC</i>	<i>CDXB2222FC</i>	<i>CDXB2223FC</i>	<i>CDXB2224FC</i>	<i>CDXB2225FC</i>
<i>CDXB2226FC</i>	<i>CDXB2227FC</i>	<i>CDXB2228FC</i>	<i>Replace "FC" with "OC" or "IC" for spare outer or inner cover</i>			

**BAC SYSTEM FOR
CORPUS BACK
SUPPORTS**



<i>CDBAC1420</i>	<i>CDBAC1421</i>	<i>CDBAC1422</i>	<i>CDBAC1423</i>	<i>CDBAC1424</i>	<i>CDBAC1425</i>	<i>CDBAC1426</i>
<i>CDBAC1427</i>	<i>CDBAC1428</i>	<i>CDBAC1620</i>	<i>CDBAC1621</i>	<i>CDBAC1622</i>	<i>CDBAC1623</i>	<i>CDBAC1624</i>
<i>CDBAC1625</i>	<i>CDBAC1626</i>	<i>CDBAC1627</i>	<i>CDBAC1628</i>	<i>CDBAC1820</i>	<i>CDBAC1821</i>	<i>CDBAC1822</i>
<i>CDBAC1823</i>	<i>CDBAC1824</i>	<i>CDBAC1825</i>	<i>CDBAC1826</i>	<i>CDBAC1827</i>	<i>CDBAC1828</i>	<i>CDBAC2020</i>
<i>CDBAC2021</i>	<i>CDBAC2022</i>	<i>CDBAC2023</i>	<i>CDBAC2024</i>	<i>CDBAC2025</i>	<i>CDBAC2026</i>	<i>CDBAC2027</i>
<i>CDBAC2028</i>	<i>CDBAC2220</i>	<i>CDBAC2221</i>	<i>CDBAC2222</i>	<i>CDBAC2223</i>	<i>CDBAC2224</i>	<i>CDBAC2225</i>
<i>CDBAC2226</i>	<i>CDBAC2227</i>	<i>CDBAC2228</i>				



Dreamline Visual Code Directory 2026

› Trunk Lateral Support Hardware

Trunk Lateral Support Hardware

FIXED TRUNK LATERAL SUPPORT HARDWARE



DFL

- Depth and Width Adjustable
- NOTE: Includes Lateral Bracket and Pad fastener kits (pg 102)

FIXED ANGLE ADJUSTABLE TRUNK LATERAL SUPPORT HARDWARE



DFLA

- Depth and Width Adjustable
- NOTE: Includes Lateral Bracket and Pad fastener kits (pg 102)

IGNITE ACTIVE BACK SUPPORT OFFSET LATERAL BRACKETS

Sold in pairs

DIBAOL

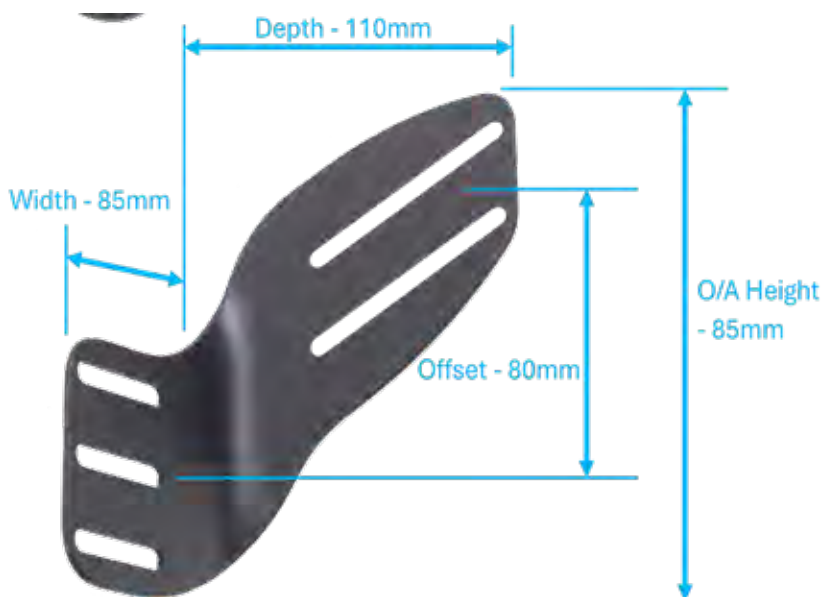

Trunk Lateral Support Hardware *cont.*

ORIGINAL SWING-AWAY TRUNK LATERAL SUPPORT HARDWARE

ORIGINAL LATERAL BRACKET (NON PIVOT)



LEFT	RIGHT
DSALL	DSALR

• NOTE: Includes Lateral Bracket and Pad fastener kits (pg 102)

ORIGINAL LATERAL BRACKET (PIVOT)



LEFT	RIGHT
DSALPL	DSALPR

• NOTE: Includes Lateral Bracket and Pad fastener kits (pg 102)

ORIGINAL LO-RISER LATERAL BRACKET (NON PIVOT)



LEFT	RIGHT
DSALLRL	DSALLRR
LEFT - KIDS	RIGHT - KIDS
DSALLRKL	DSALLRKR

• NOTE: Includes Lateral Bracket and Pad fastener kits (pg 102)

ORIGINAL LO-RISER LATERAL BRACKET (PIVOT)



LEFT	RIGHT
DSALLRPL	DSALLRPR
LEFT - KIDS	RIGHT - KIDS
DSALLRPKL	DSALLRPKR

• NOTE: Includes Lateral Bracket and Pad fastener kits (pg 102)

ORIGINAL CLAMP-ON LATERAL BRACKET (NON PIVOT)



LEFT	RIGHT
DSALCLL	DSALCLR

• NOTE: Includes Lateral Pad fastener kit (pg 102)

ORIGINAL CLAMP-ON LATERAL BRACKET (PIVOT)



LEFT	RIGHT
DSALCPL	DSALCPR

• NOTE: Includes Lateral Pad fastener kit (pg 102)

LATERAL PADS SOLD SEPARATELY

Saddleback Trunk Lateral Support Hardware

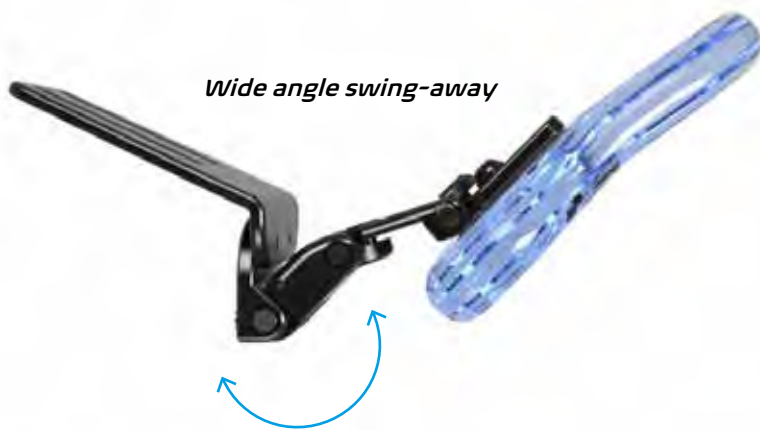
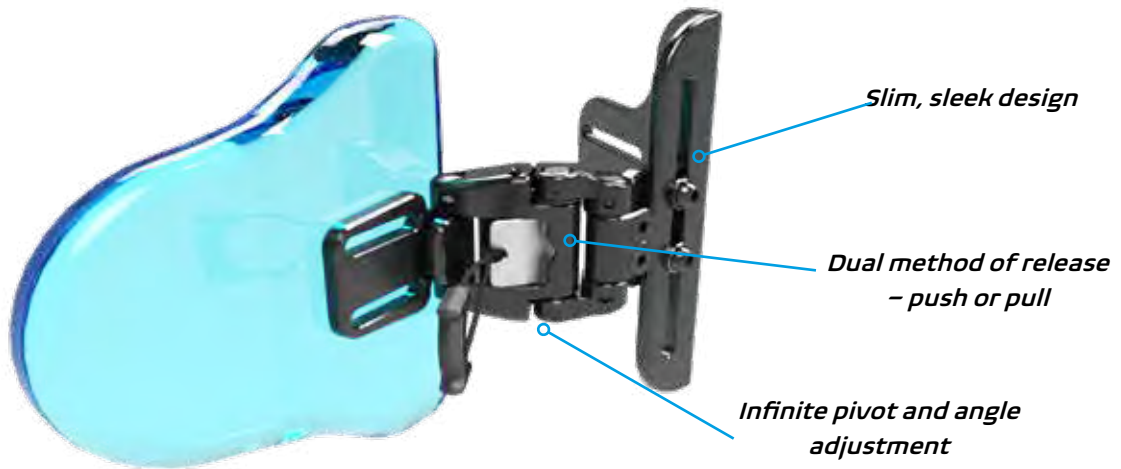

Saddleback Trunk Lateral Support Hardware *cont.*

SADDLEBACK SWING-AWAY LATERAL BRACKET (NON-PIVOT)



DLSA

• NOTE: Includes Lateral Bracket and Pad fastener kits (pg 102)

SADDLEBACK SWING-AWAY LATERAL BRACKET (PIVOT)



DLSAP

• NOTE: Includes Lateral Bracket and Pad fastener kits (pg 102)

SADDLEBACK LO-RISER SWING-AWAY LATERAL BRACKET (NON-PIVOT)



DLSALR	STD BRACKET
DLSALRK	KIDS (SMALL L-BKT FOR TINY Back Supports)

• NOTE: Includes Lateral Bracket and Pad fastener kits (pg 102)

SADDLEBACK LO-RISER SWING-AWAY LATERAL BRACKET (PIVOT)



DLSALRP	STD BRACKET
DLSALRPK	KIDS (SMALL L-BKT FOR TINY Back Supports)

• NOTE: Includes Lateral Bracket and Pad fastener kits (pg 102)

SADDLEBACK CLAMP-ON SWING-AWAY LATERAL BRACKET (NON-PIVOT)



DLSAC

• NOTE: Includes Lateral Pad fastener kit (pg 102)

SADDLEBACK CLAMP-ON SWING-AWAY LATERAL BRACKET (PIVOT)



DLSACP

• NOTE: Includes Lateral Pad fastener kit (pg 102)

LATERAL PADS SOLD SEPARATELY

Trunk Lateral Support Pads

STRAIGHT LATERAL PAD



	SIZE	L	H	C
DLPPSXSM	X-SML	145mm	105mm	0
DLPPSSML	SML	155mm	110mm	0
DLPPSMED	MED	172mm	117mm	0
DLPPSLGE	LGE	203mm	140mm	0

CURVED LATERAL PAD

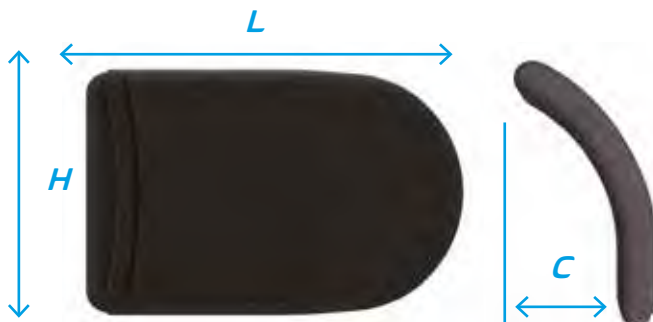

	SIZE	L	H	C
DLPPCXSM	X-SML	145mm	105mm	20mm
DLPPCSML	SML	155mm	110mm	25mm
DLPPCMED	MED	172mm	117mm	28mm
DLPPCLGE	LGE	203mm	140mm	35mm

ANTERIOR CURVED LATERAL PAD



	SIZE	L	H	C
DLPPASML	SML	220mm	95mm	ADJUSTABLE
DLPPAMED	MED	260mm	105mm	ADJUSTABLE
DLPPALGE	LGE	310mm	115mm	ADJUSTABLE

• Anterior pads can be formed to the users bodyshape.

Trunk Lateral Support Pads *cont.*

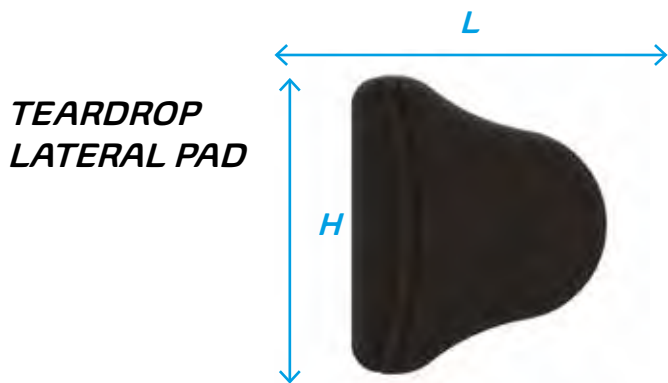

	<i>SIZE</i>	<i>L</i>	<i>H</i>	<i>C</i>
<i>DLPPTDSML</i>	<i>SML</i>	<i>155mm</i>	<i>155mm</i>	<i>15mm</i>
<i>DLPPTDMED</i>	<i>MED</i>	<i>170mm</i>	<i>187mm</i>	<i>17mm</i>
<i>DLPPTDLGE</i>	<i>LGE</i>	<i>190mm</i>	<i>227mm</i>	<i>20mm</i>
<i>DLPPCUSTXL</i>	<i>CUSTOM</i>	<i>XXX</i>	<i>XXX</i>	<i>XXX</i>

Trunk Lateral Support Accessories

**LATERAL PAD
SPARE COVERS**

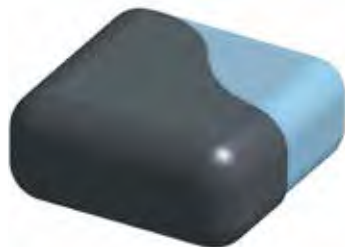

<i>ST / CV</i>	<i>ANTERIOR</i>	<i>TEARDROP</i>
<i>DLPSXSMLLOC</i>	<i>DLPAXSMLLOC</i>	<i>DLPTDSMLLOC</i>
<i>DLPSSMLOC</i>	<i>DLPASMLOC</i>	<i>DLPTDMEDOC</i>
<i>DLPSMEDOC</i>	<i>DLPAMEDOC</i>	<i>DLPTDLGEOC</i>
<i>DLPSLGEOC</i>	<i>DLPALGEOC</i>	

Trunk Lateral Support Accessories cont.

ORIGINAL LATERAL BRACKET EXTRA LINK



DSALEXTL

SADDLEBACK LATERAL BRACKET EXTRA LINK

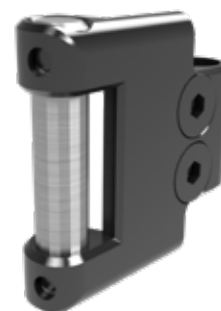

DLSAEXTL

LATERAL BRACKET PROTECTIVE BOOT



ORIGINAL BRACKET BOOT	DSALBOOT
SADDLEBACK BRACKET BOOT	DLSABOOT

DREAMLINE LATERAL INTERFACE BRACKET FOR CORPUS BACK SUPPORT



CDSALLBKT

Trunk Lateral Support Modifications

LATERAL PAD CUT-OUT MOD



DLPMODC

LATERAL PAD GEL OVERLAY MOD



DLPMODGO

DARTEX SMOOTH WIPEABLE COVER MOD

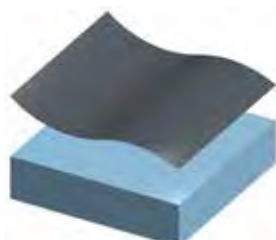

DLPMODCPU

CUSTOM FABRIC (OTHER) MOD

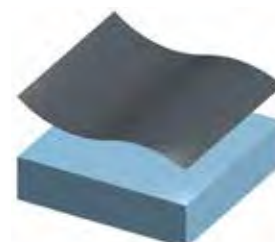

DLPMODCF

Trunk Lateral Support Modifications *cont.*

COLOUR MOD
- RED



DLPMODRED

COLOUR MOD
- BLUE



DLPMODBLU

COLOUR MOD
- ORANGE



DLPMODORA

COLOUR MOD
- GREEN



DLPMODGRE

COLOUR MOD
- PURPLE



DLPMODPUR

COLOUR MOD
- YELLOW



DLPMODYEL

COLOUR MOD
- SILVER



DLPMODSIL

COLOUR MOD
- PINK



DLPMODPIN



Dreamline Visual Code Directory 2026

› Head Supports

Saddleback Head Support Hardware

SADDLEBACK HEAD SUPPORT BRACKET



DHR

• NOTE: Includes Head Support bracket fastener kit (pg 103)

Square headrest stem is 13mm²

Head Support Mount fits hole centers 48mm-51mm

210mm

SADDLEBACK HEAD SUPPORT SWING-DOWN BRACKET



DHRS

• NOTE: Includes Head Support bracket fastener kit (pg 103)

Square headrest stem is 13mm²

MAX FORWARD REACH (WITHOUT EXTRA LINKS)

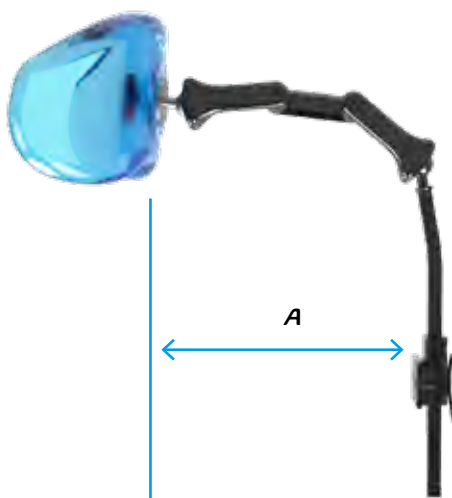

MAX REARWARD REACH



WIDE ANGLE SWING-DOWN



A = 280mm from Head Support mount to Head Support pad front face (without extra links)
 B = 65mm from Head Support mount rearward to headrest pad front face

Head Support Pads

ASSIST HEAD SUPPORT PAD



CODE	SIZE	W	H	C
DHPASML	SML	220mm	117mm	20mm
DHPALGE	LGE	240mm	125mm	25mm

CONTOURED HEAD SUPPORT PAD



CODE	SIZE	W	H	C
DHPCXSML	X-SML	160mm	95mm	50mm
DHPCSML	SML	230mm	117mm	100mm
DHPCLGE	LGE	270mm	140mm	115mm

Head Support Pads *cont.*

OPEN-CURVED HEAD SUPPORT PAD

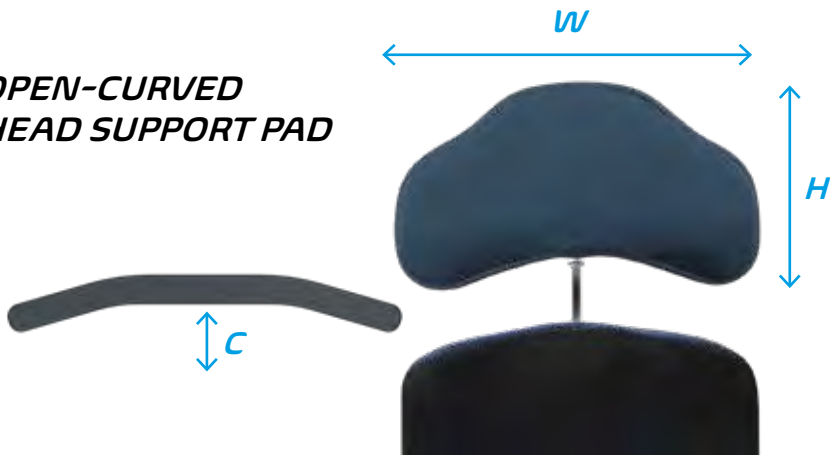

CODE	SIZE	W	H	C
DHPOCSML	SML	300mm	150mm	35mm
DHPOCLGE	LGE	400mm	185mm	35mm

PIVOT-WING HEAD SUPPORT PAD

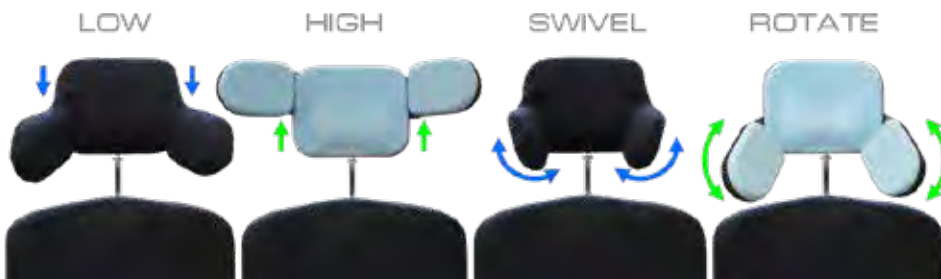
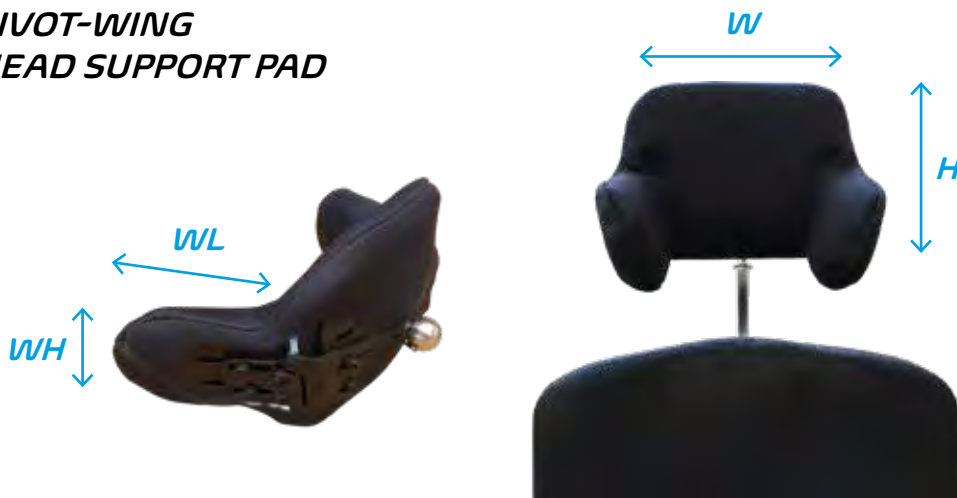

CODE	SIZE	W	H	WL	WH
DHPPWSML	SML	185mm	140mm	118mm	80mm
DHPPWLGE	LGE	205mm	158mm	118mm	80mm

Saddleback Head Support Systems

SADDLEBACK QUAD PAD HEAD SUPPORT SYSTEM

CODE	SIZE
DHPSQPSML	SML
DHPSQPLGE	LGE



• NOTE: Codes for Wing pad Only
Small - DHPSTPWSML
Large - DHPSTPWLGE

CODE	SIZE	WL	WH
DHPSQPSML	SML	155mm	65mm
DHPSQPLGE	LGE	180mm	70mm

SADDLEBACK TRI-PAD HEAD SUPPORT SYSTEM

CODE	SIZE
DHPSTPSML	SML
DHPSTPLGE	LGE



• NOTE: Codes for Rear Pad Only
Small - DHPSTPRPSML
Large - DHPSTPRPLGE

CODE	SIZE	W	H	WL	WH
DHPSTPSML	SML	160mm	90mm	155mm	65mm
DHPSTPLGE	LGE	210mm	90mm	180mm	70mm

SADDLEBACK SWING AWAY HEAD SUPPORT WING PAD



CODE	PART	L	H
DHPSLSAO	OVAL PAD	100mm	75mm
DHPSLSA	SWING AWAY HARDWARE		

Head Support Accessories

EXTRA LINK



DHRLINK

SADDLEBACK HEAD SUPPORT MOUNT

Head Support Mount fits hole centers 48mm-51mm



DHRM

DREAMLINE HEAD SUPPORT TO CORPUS OFFSET BRACKET



CDHIFB

HEAD SUPPORT TOP ARM ASSEMBLY



DHRTA

SADDLEBACK HEAD SUPPORT HEX RING



DHRHX

HEAD SUPPORT UTILITY RAIL

For offset or dual post mounting



DHRUR

SADDLEBACK HEAD SUPPORT PAD BALL



DAHPB

Head Support Accessories *cont.*

**HEAD SUPPORT
SPARE OUTER
COVER**

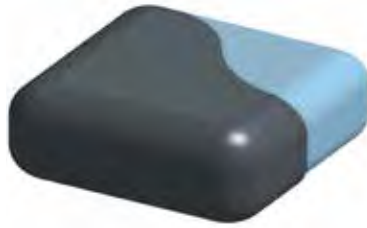

	<i>X-SML</i>	<i>SML</i>	<i>LGE</i>
<i>ASSIST</i>	-	<i>DHPASMLLOC</i>	<i>DHPALGEOC</i>
<i>CONTOURED</i>	<i>DHPCXSMLOC</i>	<i>DHPCSMLOC</i>	<i>DHPCLGEOC</i>
<i>OPEN CURVED</i>	-	<i>DHPOCSMLOC</i>	<i>DHPOCLGEOC</i>
<i>PIVOT-WING</i>	-	<i>DHPPWSMLOC</i>	<i>DHPPWLGEOC</i>
<i>WING PAD</i>	-	<i>DHPSTPWSMLOC</i>	<i>DHPSTPWLGEOC</i>
<i>REAR PAD</i>	-	<i>DHPSTPRPSMLOC</i>	<i>DHPSTPRPLGEOC</i>
<i>OVAL PAD</i>	-	<i>DHPSLSAOOC</i>	-

Head Support Modifications

**DARTEX SMOOTH
WIPEABLE COVER**

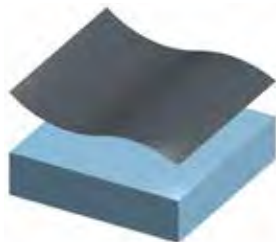

DHPMODCPU

**OTHER FABRIC
(CONTACT SURFACE)**

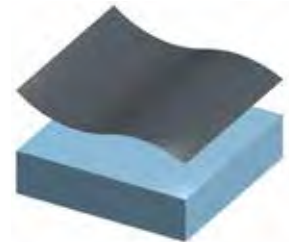

DHPMODCF

**EXTRA SUNMATE
FOAM OVERLAY**



DHPMODSFO

**HEAD SUPPORT
DUAL POST**



DHPMODDP

**HEAD SUPPORT
PAD GEL OVERLAY
MOD**



DHPMODGO

Head Support Modifications *cont.*

COLOUR MOD
- RED



DHPMODRED

COLOUR MOD
- BLUE



DHPMODBLU

COLOUR MOD
- ORANGE



DHPMODORA

COLOUR MOD
- GREEN



DHPMODGRE

COLOUR MOD
-PURPLE



DHPMODPUR

COLOUR MOD
- YELLOW



DHPMODYEL

COLOUR MOD
- SILVER



DHPMODSIL

COLOUR MOD
-PINK



DHPMODPIN



Dreamline Visual Code Directory 2026

*› Hip Guides
and Arm Supports*

Hip Guides

SWING-DOWN / REMOVABLE HIP GUIDE / ARM SUPPORT BRACKET

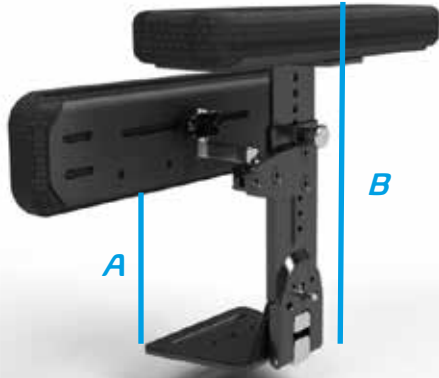

HEIGHT FROM SEAT PAN		
	MIN	MAX (Std/Pivot)
A (mm)	55	125 / 160
B (mm)	245	325

SWING-DOWN HIP GUIDE BRACKET



DHGSD

• NOTE: Includes Fastener Kit
(pg 102)

SWING-DOWN PIVOT HIP GUIDE BRACKET



DHGSDP

• NOTE: Includes Fastener Kit
(pg 102)

Hip Guides *cont.*

HIP GUIDE PAD



A (mm)	85	85	105	105	105	XXX
B (mm)	250	300	350	400	450	XXX
CODE	DHGP10	DHGP12	DHGP14	DHGP16	DHGP18	DHGPCUST

Arm Support

ARM SUPPORT COMPLETE INCLUDING VERTICAL STEM

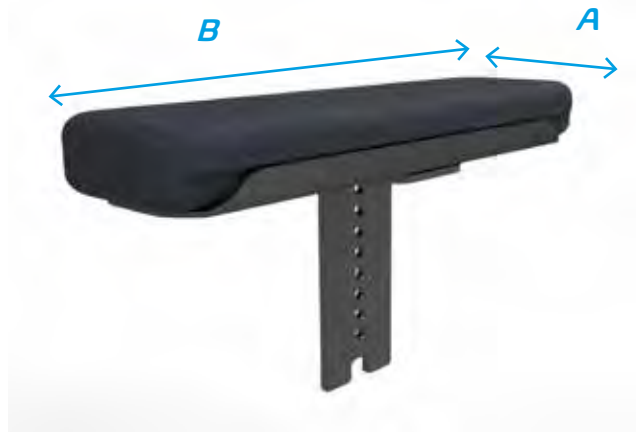

A (mm)	85	85	105	105	105	XXX
B (mm)	250	300	350	400	450	XXX
CODE	DAR10	DAR12	DAR14	DAR16	DAR18	DARCUST

FOR LONG STEM OPTION ADD "L" BETWEEN THE LETTERS AND THE SIZE

ARM SUPPORT PAD ONLY



A (mm)	85	85	105	105	105	XXX
B (mm)	250	300	350	400	450	XXX
CODE	DARP10	DARP12	DARP14	DARP16	DARP18	DARPCUST

Hip Guide and Arm Support Accessories

HIP GUIDE SPARE OUTER COVER

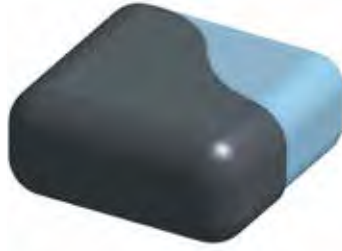

<i>DHGP100C</i>	<i>DHGP120C</i>	<i>DHGP140C</i>
<i>DHGP160C</i>	<i>DHGP180C</i>	<i>DHGPCUSTOC</i>

ARM SUPPORT SPARE OUTER COVER

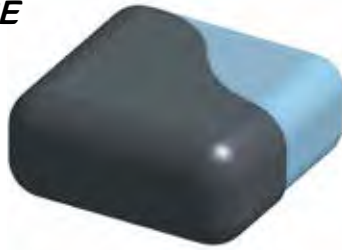

<i>DARP100C</i>	<i>DARP120C</i>	<i>DARP140C</i>
<i>DARP160C</i>	<i>DARP180C</i>	<i>DARPCUSTOC</i>

HIP GUIDE EXTRA PAD SPACER ONLY



<i>DHGSPACER</i>

Hip Guide and Arm Support Accessories *cont.*

ELBOW BLOCK



<i>W x H (mm)</i>	<i>80 X 80</i>	<i>95 X 85</i>	<i>100 X 100</i>
<i>CODE</i>	<i>DELBBLKSML</i>	<i>DELBBLKMED</i>	<i>DELBBLKLGE</i>

ARM BLOCK



<i>L x H (mm)</i>	<i>80 X 80</i>	<i>155 X 85</i>	<i>205 X 100</i>	<i>xxx</i>
<i>CODE</i>	<i>DARMBLKSML</i>	<i>DARMBLKMED</i>	<i>DARMBLKLGE</i>	<i>DARMBLKCUST</i>

Hip Guide and Arm Support Modifications

GEL OVERLAY MOD



<i>HIP GUIDE</i>	<i>DHGMODGO</i>
<i>ARM SUPPORT</i>	<i>DARMODGO</i>

DARTEX COVER SMOOTH MOD

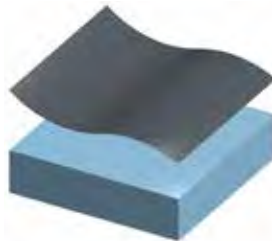

<i>HIP GUIDE</i>	<i>DHGMODCPU</i>
<i>ARM SUPPORT</i>	<i>DARMODCPU</i>

CUSTOM FABRIC MOD

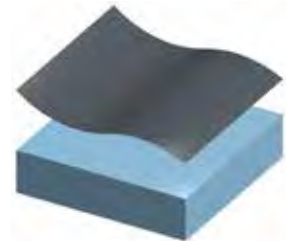

<i>HIP GUIDE</i>	<i>DHGMODCF</i>
<i>ARM SUPPORT</i>	<i>DARMODCF</i>

Hip Guide and Arm Support Modifications

cont.

COLOUR MOD
- RED



<i>HIP GUIDE</i>	<i>DHGMODRED</i>
<i>ARM SUPPORT</i>	<i>DARMODRED</i>

COLOUR MOD
- BLUE



<i>HIP GUIDE</i>	<i>DHGMODBLU</i>
<i>ARM SUPPORT</i>	<i>DARMODBLU</i>

COLOUR MOD
- ORANGE



<i>HIP GUIDE</i>	<i>DHGMODORA</i>
<i>ARM SUPPORT</i>	<i>DARMODORA</i>

COLOUR MOD
- GREEN



<i>HIP GUIDE</i>	<i>DHGMODGRE</i>
<i>ARM SUPPORT</i>	<i>DARMODGRE</i>

COLOUR MOD
-PURPLE



<i>HIP GUIDE</i>	<i>DHGMODPUR</i>
<i>ARM SUPPORT</i>	<i>DARMODPUR</i>

COLOUR MOD
- YELLOW



<i>HIP GUIDE</i>	<i>DHGMODYEL</i>
<i>ARM SUPPORT</i>	<i>DARMODYEL</i>

COLOUR MOD
- SILVER



<i>HIP GUIDE</i>	<i>DHGMODSIL</i>
<i>ARM SUPPORT</i>	<i>DARMODSIL</i>

COLOUR MOD
-PINK



<i>HIP GUIDE</i>	<i>DHGMODPIN</i>
<i>ARM SUPPORT</i>	<i>DARMODPIN</i>



Dreamline Visual Code Directory 2026

› Medial Thigh Supports

Medial Thigh Support

SWING-DOWN / REMOVABLE MEDIAL THIGH SUPPORT BRACKET

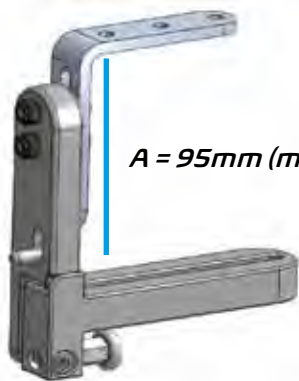

A = 95mm (min) - 135mm (max)

DPSD

• NOTE: Includes Fastener Kit (pg 103)

MEDIAL THIGH SUPPORT PAD



<i>DPPPSML</i>
<i>DPPPMED</i>
<i>DPPPLGE</i>
<i>DPPPCUSTOM</i>

PAD DIMENSIONS



	<i>SMALL</i>	<i>MEDIUM</i>	<i>LARGE</i>
<i>WF (mm)</i>	70	95	115
<i>WR (mm)</i>	50	60	85
<i>L (mm)</i>	110	150	180
<i>H (mm)</i>	90	100	110

WATERFALL MEDIAL THIGH SUPPORT PAD



<i>DPPWPSML</i>
<i>DPPWPMED</i>
<i>DPPWPLGE</i>
<i>DPPWPCUST</i>

WATERFALL PAD DIMENSIONS



	<i>SMALL</i>	<i>MEDIUM</i>	<i>LARGE</i>
<i>WF (mm)</i>	70	85	115
<i>WR (mm)</i>	50	60	85
<i>LT (mm)</i>	110	150	180
<i>LB (mm)</i>	45	60	60
<i>HF (mm)</i>	145	155	165
<i>HR (mm)</i>	90	100	110

Medial Thigh Support Accessories



**MEDIAL THIGH SUPPORT
PAD OUTER COVER**

<i>DPPSMLOC</i>	<i>DPPMEDOC</i>	<i>DPPLGEOC</i>	<i>DPPCUSTOC</i>
-----------------	-----------------	-----------------	------------------

**WATERFALL MEDIAL THIGH
SUPPORT OUTER COVER**



<i>DPPWSMLOC</i>	<i>DPPWMEDOC</i>	<i>DPPWLGEOC</i>	<i>DPPWCUSTOC</i>
------------------	------------------	------------------	-------------------

**MEDIAL THIGH SUPPORT BRACKET
PROTECTIVE SLEEVE**

<i>DPSDPS</i>



Medial Thigh Support Modifications

**GEL OVERLAY
MOD**



<i>DPPMODGO</i>

**DARTEX FABRIC
SMOOTH MOD**

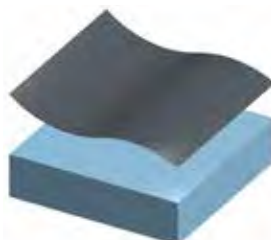

<i>DPPMODCPU</i>

**CUSTOM FABRIC
MOD**

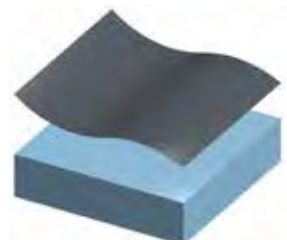

<i>DPPMODCF</i>

Medial Thigh Support Modifications *cont.*

COLOUR MOD
- RED



DPPMODRED

COLOUR MOD
- BLUE



DPPMODBLU

COLOUR MOD
- ORANGE



DPPMODORA

COLOUR MOD
- GREEN



DPPMODGRE

COLOUR MOD
- PURPLE



DPPMODPUR

COLOUR MOD
- YELLOW



DPPMODYEL

COLOUR MOD
- SILVER



DPPMODSIL

COLOUR MOD
- PINK



DPPMODPIN



Dreamline Visual Code Directory 2026

*› Hip Belts,
Harnesses
and Calf Straps*

Harnesses

H2X HARNESS



<i>CODE</i>	<i>SIZE</i>	<i>W</i>	<i>CW</i>	<i>H</i>
<i>DH2XXSML</i>	<i>X-SML</i>	<i>210mm</i>	<i>120mm</i>	<i>325mm</i>
<i>DH2XSML</i>	<i>SML</i>	<i>280mm</i>	<i>120mm</i>	<i>380mm</i>
<i>DH2XMED</i>	<i>MED</i>	<i>370mm</i>	<i>150mm</i>	<i>440mm</i>
<i>DH2XLGE</i>	<i>LGE</i>	<i>420mm</i>	<i>180mm</i>	<i>505mm</i>
<i>DH2XXLGE</i>	<i>X-LGE</i>	<i>520mm</i>	<i>180mm</i>	<i>590mm</i>

Harness Accessories

HARNESS PROTECTOR SLEEVES



<i>X-SML</i>	<i>SML</i>	<i>MED</i>	<i>LGE</i>	<i>X-LGE</i>
<i>DH2XPSXSML</i>	<i>DH2XPSSML</i>	<i>DH2XPSMED</i>	<i>DH2XPSLGE</i>	<i>DH2XPSXLGE</i>

HARNESS RETAINER KIT



DHRK

Harness Modifications

**PROTECTOR
SLEEVE DARTEX
SMOOTH SIDE
MODIFICATION**

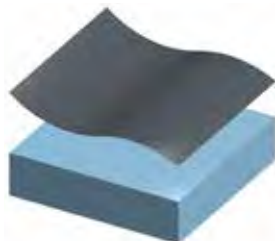

DH2XPSMODPU

**ATTACHMENT
BOLT HOLES ADDED
TO STRAPS
MODIFICATION**



DHBHMODSH

Harness Protector Sleeve Modifications *cont.*

COLOUR MOD
- RED



DH2XPSMODRED

COLOUR MOD
- BLUE



DH2XPSMODBLU

COLOUR MOD
- ORANGE



DH2XPSMODORA

COLOUR MOD
- GREEN



DH2XPSMODGRE

COLOUR MOD
- PURPLE



DH2XPSMODPUR

COLOUR MOD
- YELLOW



DH2XPSMODYEL

COLOUR MOD
- SILVER



DH2XPSMODSIL

COLOUR MOD
- PINK



DH2XPSMODPIN

Hip Belts

HIP BELT PAD MEASUREMENTS

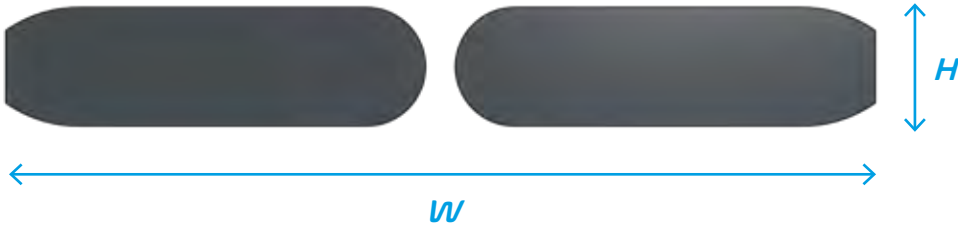

	<i>X-SML</i>	<i>SML</i>	<i>MED</i>	<i>LGE</i>
<i>W</i>	330mm	400mm	490mm	570mm
<i>H</i>	55mm	65mm	65mm	75mm

2-POINT CENTRE PULL SIDE RELEASE



<i>X-SML</i>	<i>SML</i>	<i>MED</i>	<i>LGE</i>
<i>DHB2CPXSML</i>	<i>DHB2CPSML</i>	<i>DHB2CPMED</i>	<i>DHB2CPLGE</i>

2-POINT CENTRE PULL CENTRE RELEASE



<i>SML</i>	<i>MED</i>	<i>LGE</i>
<i>DHB2CMSML</i>	<i>DHB2CMMED</i>	<i>DHB2CMLGE</i>

2-POINT DUAL CENTRE PULL



<i>X-SML</i>	<i>SML</i>	<i>MED</i>	<i>LGE</i>
<i>DHB2DPXSML</i>	<i>DHB2DPSML</i>	<i>DHB2DPMED</i>	<i>DHB2DPLGE</i>

Hip Belts *cont.*

4-POINT CENTRE PULL SIDE RELEASE



<i>X-SML</i>	<i>SML</i>	<i>MED</i>	<i>LGE</i>
<i>DHB4CPXSML</i>	<i>DHB4CPSML</i>	<i>DHB4CPMED</i>	<i>DHB4CPLGE</i>

4-POINT CENTRE PULL CENTRE RELEASE



<i>SML</i>	<i>MED</i>	<i>LGE</i>
<i>DHB4CMSML</i>	<i>DHB4CMMED</i>	<i>DHB4CMLGE</i>

4-POINT DUAL CENTRE PULL



<i>X-SML</i>	<i>SML</i>	<i>MED</i>	<i>LGE</i>
<i>DHB4DPXSML</i>	<i>DHB4DPSML</i>	<i>DHB4DPMED</i>	<i>DHB4DPLGE</i>

Hip Belts *cont.*

4-POINT REAR PULL SIDE RELEASE



<i>SML</i>	<i>MED</i>	<i>LGE</i>
<i>DHB4RPSML</i>	<i>DHB4RPMED</i>	<i>DHB4RPLGE</i>

4-POINT REAR PULL REAR RELEASE



<i>SML</i>	<i>MED</i>	<i>LGE</i>
<i>DHB4RMSML</i>	<i>DHB4RMMED</i>	<i>DHB4RMLGE</i>

Hip Belt Accessories

HIP BELT GEL PADS



<i>SML</i>	<i>DHBGELSLVSML</i>
<i>MED</i>	<i>DHBGELSLVMED</i>
<i>LGE</i>	<i>DHBGELSLVLGE</i>

TRI-BAR ADJUSTER 25MM



DTBA25

TRI-BAR ADJUSTER 38MM



DTBA38

TRIANGLE MOUNT 25MM



DTRIMOUNT25

TRIANGLE MOUNT 38MM



DTRIMOUNT38

Padded Calf Straps

Attached with four hook and loop straps around the wheelchair leg hanger posts.



WHEELCHAIR WIDTH	12"	14"	16"	17"	18"	20"	CUSTOM
CODE	DPCS12	DPCS14	DPCS16	DPCS17	DPCS18	DPCS20	DPCSCUST
W	315mm	365mm	415mm	440mm	470mm	520mm	XX
H	90mm	100mm	110mm	110mm	130mm	130mm	XX

Padded Calf Strap Modifications

BUCKLE ATTACHMENT MODIFICATION



DPCSMODBK

GEL OVERLAY MOD



DPSCSMODGO



Dreamline Visual Code Directory 2026

› *Fasteners*

Fasteners

SWING-AWAY LATERAL TO BACK SUPPORT FASTENER KIT



CODE	CONSISTS OF:	SIZE	QTY
DFKLAT	STAINLESS STEEL COACH BOLT	M6 X 25mm	2
	STAINLESS STEEL NYLOC NUT	M6	2
	LARGE ALUMINIUM WASHER	M6 X 25mm	2
	FIXING PLATE (2 HOLE)	-	1

LATERAL PAD FASTENER KIT (NON-PIVOT)



CODE	CONSISTS OF:	SIZE	QTY
DFKLATPADN	STAINLESS STEEL BUTTON HEX SCREW	M6 X 16mm	2
	STAINLESS STEEL SPRING WASHER	M6	2
	STAINLESS STEEL FLAT WASHER	M6 X 12mm	2

LATERAL PAD FASTENER KIT (PIVOT)



CODE	CONSISTS OF:	SIZE	QTY
DFKLATPADP	STAINLESS STEEL BUTTON HEX SCREW	M6 X 20mm	2
	STAINLESS STEEL SPRING WASHER	M6	2

HIP GUIDE BRACKET FASTENER KIT



CODE	CONSISTS OF:	SIZE	QTY
DFKHG	STAINLESS STEEL COACH BOLT	M6 X 25mm	2
	STAINLESS STEEL NYLOC NUT	M6	2
	LARGE ALUMINIUM WASHER	M6 X 25mm	2

Fasteners *cont.*



HEAD SUPPORT BRACKET FASTENER KIT

CODE	CONSISTS OF:	SIZE	QTY
DFKHR	STAINLESS STEEL COACH BOLT	M6 X 20mm	2
	STAINLESS STEEL NYLOC NUT	M6	2
	STAINLESS STEEL FLAT WASHER	M6 X 12mm	2
	FIXING PLATE (3 HOLE)	-	1



MEDIAL THIGH SUPPORT BRACKET FASTENER KIT

CODE	CONSISTS OF:	SIZE	QTY
DFKPSD	STAINLESS STEEL COACH BOLT	M6 X 20mm	2
	STAINLESS STEEL NYLOC NUT	M6	2
	LARGE ALUMINIUM WASHER	M6 X 25mm	2



IGNITE PRO LATERAL EXTRA FASTENING KIT

CODE	CONSISTS OF:	SIZE	QTY
DFKIPB	STAINLESS STEEL COACH BOLT	M6 X 16mm	2
	STAINLESS STEEL NYLOC NUT	M6	2
	STAINLESS STEEL FLAT WASHER	M6 X 18mm	2



HARNESS RETAINER FASTENING KIT

CODE	CONSISTS OF:	SIZE	QTY
DHRFK	STAINLESS STEEL COACH BOLT	M6 X 16mm	2
	STAINLESS STEEL NYLOC NUT	M6	2
	STAINLESS STEEL FLAT WASHER	M6 X 12mm	2

Fasteners cont.

**M6 COACH NUT
(PK OF 20)**



DFASCNM6

**HEAD SUPPORT
MOUNT KNOB**



DFASKNOBM6

**FIXING PLATE
(2 HOLE) PK OF 20**



DFASFXP2HOLBPK20

**FIXING PLATE
(3 HOLE) PK OF 20**



DFASFXP3HOLBPK20

**STAINLESS STEEL
BUTTON HEX SCREW**



**STAINLESS STEEL
CAP SCREW**



SIZE	CODE (PK OF 20)
M6 X 10mm	DFASBHM610SPK20
M6 X 12mm	DFASBHM612BPK20
M6 X 16mm	DFASBHM616BPK20
M6 x 20mm	DFASBHM620BPK20
M6 x 25mm	DFASBHM625BPK20
M6 x 30mm	DFASBHM630BPK20
M6 x 40mm	DFASBHM640BPK20

SIZE	CODE (PK OF 20)
M5 X 12mm	DFASCSM512SPK20
M5 x 20mm	DFASCSM520BPK20
M6 x 12mm	DFASCSM612BPK20
M6 x 25mm	DFASCSM625BPK20
M6 x 30mm	DFASCSM630BPK20
M6 x 35mm	DFASCSM635BPK20

**STAINLESS STEEL
COUNTERSUNK HEX
SCREW**



**STAINLESS STEEL
COACH BOLT**



SIZE	CODE (PK OF 20)
M6 X 8mm	DFASCHSM608BPK20
M6 x 10mm	DFASCHSM610BPK20
M6 x 12mm	DFASCHSM612BPK20
M6 x 16mm	DFASCHSM616BPK20
M6 x 25mm	DFASCHSM625BPK20

SIZE	CODE (PK OF 20)
M6 X 16mm	DFASCBM616BPK20
M6 x 20mm	DFASCBM620BPK20
M6 x 25mm	DFASCBM625BPK20
M6 x 30mm	DFASCBM630BPK20
M6 x 50mm	DFASCBM650BPK20
M6 x 60mm	DFASCBM660BPK20

Fasteners *cont.*

NYLOC NUT



SIZE	CODE (PK OF 20)
M5	DFASNMM5BPK20
M6	DFASNMM6BPK20

LARGE ALUMINIUM WASHER



DFASAWM625PK20

STAINLESS STEEL FLAT WASHER



SIZE	CODE (PK OF 20)
M6 x 12	DFASWFM612BPK20
M6 x 19	DFASWFM619BPK20

STAINLESS STEEL SPRING WASHER



SIZE	CODE (PK OF 20)
M6 x 12	DFASWSM6BPK20

SUPPORT SERIES BACK SUPPORT PIN



DFASSBPIN

IGNITE SERIES BACK SUPPORT PIN



DFASIBPIN

SIDEWINDER SUSPENSION PIN



DFASSSPIN

IGNITE BACK SUPPORT SHROUD



DFASIBSHD

POSITIONING CLAMPS (PR)



DSPCF

SPRING LOCK PIN

DFASSLP



- Can be used for hip-belt and harness attachment
- Fits tubing from 19mm (3/4") - 25.4mm (1")

Dreamline Service Kits

DREAMLINE ASSESSMENT KIT BAG - COMPLETE

DAKBC



ASSESSMENT KIT INCLUDES

- Dreamline Assessment Kit Bag
- Dreamline Fabric Sample Swatch
- Dreamline Foam Sample Swatch
- Dreamline Gel and Supracor Sample Swatch
- Dreamline Colour Option Sample Swatch
- STX cushion Lateral Segment 3"
- STX cushion Lateral Segment 4"
- STX cushion Lateral Segment 6"
- STX cushion Low Lateral Segment 6"
- STX cushion Low Lateral Segment 8"
- STX Cushion BAC Kit of 10 pads
- Dreamline Cluster Gel Pack
- Dreamline Cluster Resilient Foam pack
- Dreamline Cluster Sunmate Foam pack

DREAMLINE SERVICE KIT - FASTENERS

DSKF



SERVICE KIT INCLUDES

- M6 Coach Nuts (PK20)
- Head Support Mount Knob (2)
- Fixing Plate (2HOLE) (PK20)
- Fixing Plate (3HOLE) (PK20)
- Tool Kit and Spanner
- Nyloc Nut M6 (PK20)
- Large Aluminium Washer (PK20)
- SS Coach Bolt M6x16 (PK20)
- SS Coach Bolt M6x20 (PK20)
- SS Coach Bolt M6x25 (PK20)
- Ignite Back Support Shroud (PK4)
- Cap Screw M5x20 (PK20)
- SS Button Screw M6x12 (PK20)
- SS Button Screw M6x16 (PK20)
- SS Button Screw M6x20 (PK20)
- SS Button Screw M6x25 (PK20)
- SS Button Screw M6x30 (PK20)
- Flat Washer M6x12 (PK20)
- Flat Washer M6x19 (PK20)
- Spring Washer M6 (PK20)
- SS Countersunk Socket Screw M5x10 (PK20)
- SS Countersunk Socket Screw M6x8 (PK20)
- SS Countersunk Socket Screw M6x16 (PK20)
- SS Countersunk Socket Screw M6x25 (PK20)
- Cap Screw M6x12 (PK20)

Dreamline Service Kits cont.

DREAMLINE DEMO SEAT SYSTEM FULL KIT 1416

DDSFK1416



SERVICE KIT INCLUDES

- *Display Stand*
- *Display Carry Bag*
- *Dreamline G7 Cushion Complete - With Gel Ischial well - 14" x 16"*
- *Dreamline STX Back Support - Q/R Complete 14" x 16"*
- *Dreamline Quick-Release Seat Pan 14" x 16"*
- *Hip Guide / Arm Support Swing Down Quick Release Bracket Only*
- *Hip Guide / Arm Support Swing Down Quick Release Pivot Bracket Only*
- *Hip Guide Pad Only - Complete - 14"*
- *Arm Support Complete Including Vertical Stem - 14"*
- *Dreamline Saddleback Head Support Bracket - Swing-down - Complete*
- *Pivot-wing Head Support Pad Only - Small*
- *Dreamline Swing-away Lateral Bracket Only - Complete - Right*
- *Dreamline Lo-riser Swing-away Pivot Lateral Bracket Only Complete - Left*
- *Dreamline Lateral Teardrop Pad Only - Small*
- *Dreamline Lateral Anterior Pad Only - Small*
- *Swing-down Abductor Pommel - Bracket Only*
- *Swing-down Abductor Pommel - Pad Only - Small*
- *H2X Harness - Small*
- *H2X Harness - Protector Sleeves - Small*
- *Full Seating System Custom Colour Borders Blue*
- *Dreamline 4 Point Hip Belt - Rear Pull With Metal Centre Release Buckle - Small*



Dreamline Visual Code Directory 2026

› *Splash*

Commode Back Supports and Accessories

Splash Back Supports



Splash commode Back Supports enable the prescriber to replicate the set-up from the Dreamline Seating into the commode.

Splash pads use the bracketry from the Dreamline range as they are constructed from water resistant materials - Anodised Aluminium and Stainless Steel.

Splash Back Supports *cont.*

SPLASH CONTOUR BACK SUPPORT (FIXED)



<i>SCBF1414</i>	<i>SCBF1416</i>	<i>SCBF1418</i>	<i>SCBF1420</i>	<i>SCBF1616</i>	<i>SCBF1618</i>
<i>SCBF1620</i>	<i>SCBF1622</i>	<i>SCBF1816</i>	<i>SCBF1818</i>	<i>SCBF1820</i>	<i>SCBF1822</i>
<i>SCBF2018</i>	<i>SCBF2020</i>	<i>SCBF2022</i>	<i>SCBFCUST</i>	<i>SCBFCUSTXL</i>	

SPLASH SUPPORT BACK SUPPORT - FIXED



<i>SSBF1414</i>	<i>SSBF1416</i>	<i>SSBF1418</i>	<i>SSBF1420</i>	<i>SSBF1616</i>	<i>SSBF1618</i>
<i>SSBF1620</i>	<i>SSBF1622</i>	<i>SSBF1816</i>	<i>SSBF1818</i>	<i>SSBF1820</i>	<i>SSBF1822</i>
<i>SSBF2018</i>	<i>SSBF2020</i>	<i>SSBF2022</i>	<i>SSBFCUST</i>	<i>SSBFCUSTXL</i>	

SPLASH S3 BACK SUPPORT - FIXED



<i>S3BF1414</i>	<i>S3BF1416</i>	<i>S3BF1418</i>	<i>S3BF1420</i>	<i>S3BF1616</i>	<i>S3BF1618</i>
<i>S3BF1620</i>	<i>S3BF1622</i>	<i>S3BF1816</i>	<i>S3BF1818</i>	<i>S3BF1820</i>	<i>S3BF1822</i>
<i>S3BF2018</i>	<i>S3BF2020</i>	<i>S3BF2022</i>	<i>S3BFCUST</i>	<i>S3BFCUSTXL</i>	

Splash Back Support Accessories

PARTS FOR SPLASH CONTOUR BACK SUPPORTS

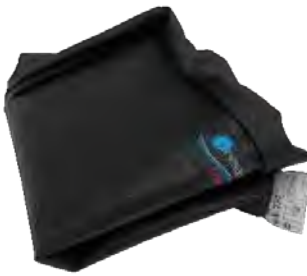

<i>SCB1414</i>	<i>SCB1416</i>	<i>SCB1418</i>	<i>SCB1420</i>	<i>SCB1616</i>	<i>SCB1618</i>
<i>SCB1620</i>	<i>SCB1622</i>	<i>SCB1816</i>	<i>SCB1818</i>	<i>SCB1820</i>	<i>SCB1822</i>
<i>SCB2018</i>	<i>SCB2020</i>	<i>SCB2022</i>	<i>SCBCUST</i>	<i>SCBCUSTXL</i>	

*Outer Cover only add "OC" to end of code • Shell and Pad only add "SP" to end of code
Foam Inner and Outer Cover only add "FC" to the end of code*

PARTS FOR SPLASH SUPPORT BACK SUPPORTS

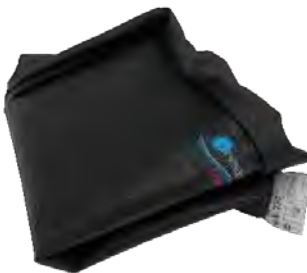

<i>SSB1414</i>	<i>SSB1416</i>	<i>SSB1418</i>	<i>SSB1420</i>	<i>SSB1616</i>	<i>SSB1618</i>
<i>SSB1620</i>	<i>SSB1622</i>	<i>SSB1816</i>	<i>SSB1818</i>	<i>SSB1820</i>	<i>SSB1822</i>
<i>SSB2018</i>	<i>SSB2020</i>	<i>SSB2022</i>	<i>SSBCUST</i>	<i>SSBCUSTXL</i>	

*Outer Cover only add "OC" to end of code • Shell and Pad only add "SP" to end of code
Foam Inner and Outer Cover only add "FC" to the end of code*

PARTS FOR SPLASH S3 BACK SUPPORTS

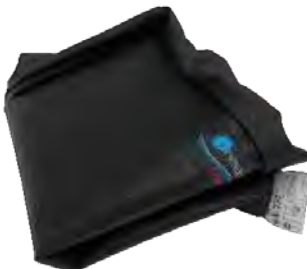

<i>S3B1414</i>	<i>S3B1416</i>	<i>S3B1418</i>	<i>S3B1420</i>	<i>S3B1616</i>	<i>S3B1618</i>
<i>S3B1620</i>	<i>S3B1622</i>	<i>S3B1816</i>	<i>S3B1818</i>	<i>S3B1820</i>	<i>S3B1822</i>
<i>S3B2018</i>	<i>S3B2020</i>	<i>S3B2022</i>	<i>S3BCUST</i>	<i>S3BCUSTXL</i>	

*Outer Cover only add "OC" to end of code • Shell and Pad only add "SP" to end of code
Foam Inner and Outer Cover only add "FC" to the end of code*

Splash Back Support Accessories *cont.*

**SPLASH BAC SYSTEM
(FOR SPLASH SUPPORT
BACK SUPPORTS)**



<i>SBACSB1414</i>	<i>SBACSB1416</i>	<i>SBACSB1418</i>	<i>SBACSB1420</i>	<i>SBACSB1616</i>	<i>SBACSB1618</i>
<i>SBACSB1620</i>	<i>SBACSB1622</i>	<i>SBACSB1816</i>	<i>SBACSB1818</i>	<i>SBACSB1820</i>	<i>SBACSB1822</i>
<i>SBACSB2018</i>	<i>SBACSB2020</i>	<i>SBACSB2022</i>	<i>SBACSBUCUST</i>	<i>SBACSBUCUSTXL</i>	

Splash Trunk Lateral Support Pads

(Uses Dreamline Bracketry)

STRAIGHT LATERAL PAD



	SIZE	L	H	C
SLPSXSML	X-SML	145mm	105mm	0
SLPSSML	SML	155mm	110mm	0
SLPSMED	MED	172mm	117mm	0
SLPSLGE	LGE	203mm	140mm	0

CURVED LATERAL PAD



	SIZE	L	H	C
SLPCXSML	X-SML	145mm	105mm	20mm
SLPCSML	SML	155mm	110mm	25mm
SLPCMED	MED	172mm	117mm	28mm
SLPCLGE	LGE	203mm	140mm	35mm

TEARDROP LATERAL PAD



	SIZE	L	H	C
SLPTDSML	SML	155mm	155mm	15mm
SLPTDMED	MED	170mm	187mm	17mm
SLPTDLGE	LGE	190mm	227mm	20mm
SLPCUSTXL	CUSTOM	XXX	XX	XXX

Splash Head Support Pads

SPLASH ASSIST HEAD SUPPORT PAD



CODE	SIZE	W	H	C
SHPASML	SML	220mm	117mm	20mm
SHPALGE	LGE	240mm	125mm	25mm

SPLASH CONTOURED HEAD SUPPORT PAD



CODE	SIZE	W	H	C
SHPCVXSML	X-SML	160mm	95mm	50mm
SHPCVSML	SML	230mm	117mm	100mm
SHPCVLGE	LGE	270mm	140mm	115mm

SPLASH OPEN-CURVED HEAD SUPPORT PAD



CODE	SIZE	W	H	C
SHPOCSML	SML	300mm	150mm	35mm
SHPOCLGE	LGE	400mm	185mm	35mm

Splash Head Support Pads *cont.*

SPLASH PIVOT-WING HEAD SUPPORT PAD

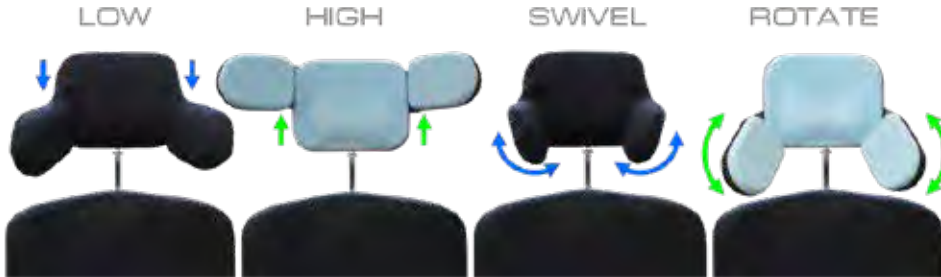

CODE	SIZE	W	H	WL	WH
SHPPWSML	SML	185mm	140mm	118mm	80mm
SHPPWLGE	LGE	205mm	158mm	118mm	80mm

Splash H2X Harness

Splash harnesses have a special water repelling coated neoprene fabric for quicker dry time.

Splash harness sizing is identical to Dreamline Harness sizes.



CODE	SIZE	W	CW	H
SH2XXSML	X-SML	210mm	120mm	325mm
SH2XSML	SML	280mm	120mm	380mm
SH2XMED	MED	370mm	150mm	440mm
SH2XLGE	LGE	420mm	180mm	505mm
SH2XXLGE	X-LGE	520mm	180mm	590mm

Splash Hip Belts

Hip-belts have a special water repelling coated neoprene fabric for quicker dry time.

2-POINT CENTRE PULL SIDE RELEASE



<i>X-SML</i>	<i>SML</i>	<i>MED</i>	<i>LGE</i>
<i>SHB2CPXSML</i>	<i>SHB2CPSML</i>	<i>SHB2CPMED</i>	<i>SHB2CPLGE</i>

2-POINT DUAL CENTRE PULL



<i>X-SML</i>	<i>SML</i>	<i>MED</i>	<i>LGE</i>
<i>SHB2DPXSML</i>	<i>SHB2DPSML</i>	<i>SHB2DPMED</i>	<i>SHB2DPLGE</i>

4-POINT CENTRE PULL SIDE RELEASE



<i>X-SML</i>	<i>SML</i>	<i>MED</i>	<i>LGE</i>
<i>SHB4CPXSML</i>	<i>SHB4CPSML</i>	<i>SHB4CPMED</i>	<i>SHB4CPLGE</i>

4-POINT DUAL CENTRE PULL



<i>X-SML</i>	<i>SML</i>	<i>MED</i>	<i>LGE</i>
<i>SHB4DPXSML</i>	<i>SHB4DPSML</i>	<i>SHB4DPMED</i>	<i>SHB4DPLGE</i>

4-POINT REAR PULL SIDE RELEASE



<i>SML</i>	<i>MED</i>	<i>LGE</i>
<i>SHB4RPSML</i>	<i>SHB4RPMED</i>	<i>SHB4RPLGE</i>



Dreamline Visual Code Directory 2026

› *Snooza Seating System*

Snooza Seating System

The all-foam Snooza Chair offers the user a safe, comfortable and supportive postural management inside the house, school or facility giving carers peace of mind.

Covered in medical grade vinyl with wipe-down surfaces and a breathable, washable comfort wrap, the Snooza Chair is easy care.

The Snooza chair is great for use with patients with epilepsy, autism and cerebral palsy etc. Gravity helps to keep the user safely in a mid-line position. The higher arm rest position promotes better blood flow and the softness of the seat allows the user to extend (e.g. during a seizure) then gently bringing them back into position.

Carry Handles make for easy transportation and large pockets are located on each side.

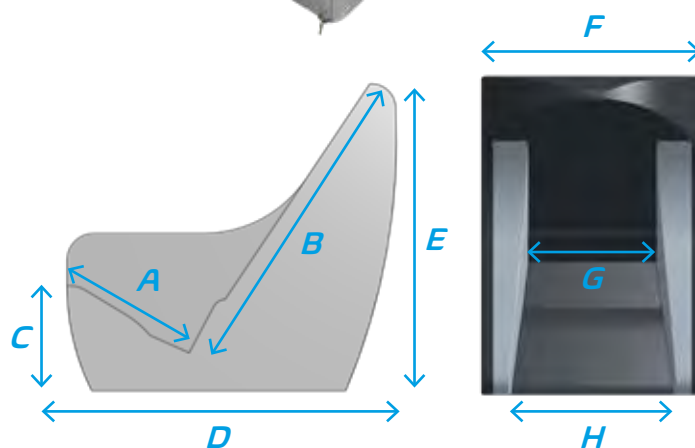

THE STANDARD KIT INCLUDES

- 1 x Chair
- 1 x Comfort Wrap
- 1 x Base Wedge
- 1 x Hip Belt

(Head Support is sold separately)

CHAIR SIZE	A) Seat Depth	B) Back Support Height	C) Floor to Seat Height	D) Overall Length	E) Overall Height	F) Overall Width	G) Seat Width at Pelvis	H) Seat Width at Front	I) Chair Weight
1	240mm	580mm	215mm	635mm	570mm	455mm	230mm	310mm	5.5kg
2	290mm	670mm	245mm	710mm	640mm	480mm	270mm	330mm	6kg
3	370mm	725mm	280mm	810mm	690mm	565mm	320mm	405mm	7.6kg
4	425mm	780mm	310mm	905mm	740mm	600mm	340mm	425mm	9.4kg

Height of armrest relative to the seat well

SIZE	Height
1	200mm
2	260mm
3	290mm
4	330mm

Snooza Seating System *cont.*

COLOUR OPTIONS



GREY



BLACK



APPLE



ROYAL BLUE



ORANGE



HOT PINK



• Excludes Head Support

CODE	DESCRIPTION
SNZAC1A	Snooza Chair with vinyl covers - Without Head Support - Size 1 Colour Apple
SNZAC1B	Snooza Chair with vinyl covers - Without Head Support - Size 1 Colour Royal Blue
SNZAC1BLK	Snooza Chair with vinyl covers - Without Head Support - Size 1 Colour Black
SNZAC1GRY	Snooza Chair with vinyl covers - Without Head Support - Size 1 Colour Grey
SNZAC1O	Snooza Chair with vinyl covers - Without Head Support - Size 1 Colour Orange
SNZAC1P	Snooza Chair with vinyl covers - Without Head Support - Size 1 Colour Hot Pink
SNZAC2A	Snooza Chair with vinyl covers - Without Head Support - Size 2 Colour Apple
SNZAC2B	Snooza Chair with vinyl covers - Without Head Support - Size 2 Colour Royal Blue
SNZAC2BLK	Snooza Chair with vinyl covers - Without Head Support - Size 2 Colour Black
SNZAC2GRY	Snooza Chair with vinyl covers - Without Head Support - Size 2 Colour Grey
SNZAC2O	Snooza Chair with vinyl covers - Without Head Support - Size 2 Colour Orange
SNZAC2P	Snooza Chair with vinyl covers - Without Head Support - Size 2 Colour Hot Pink
SNZAC3A	Snooza Chair with vinyl covers - Without Head Support - Size 3 Colour Apple
SNZAC3B	Snooza Chair with vinyl covers - Without Head Support - Size 3 Colour Royal Blue
SNZAC3BLK	Snooza Chair with vinyl covers - Without Head Support - Size 3 Colour Black
SNZAC3GRY	Snooza Chair with vinyl covers - Without Head Support - Size 3 Colour Grey
SNZAC3O	Snooza Chair with vinyl covers - Without Head Support - Size 3 Colour Orange
SNZAC3P	Snooza Chair with vinyl covers - Without Head Support - Size 3 Colour Hot Pink
SNZAC4A	Snooza Chair with vinyl covers - Without Head Support - Size 4 Colour Apple
SNZAC4B	Snooza Chair with vinyl covers - Without Head Support - Size 4 Colour Royal Blue
SNZAC4BLK	Snooza Chair with vinyl covers - Without Head Support - Size 4 Colour Black
SNZAC4GRY	Snooza Chair with vinyl covers - Without Head Support - Size 4 Colour Grey
SNZAC4O	Snooza Chair with vinyl covers - Without Head Support - Size 4 Colour Orange
SNZAC4P	Snooza Chair with vinyl covers - Without Head Support - Size 4 Colour Hot Pink

Snooza Head Support Options

LOW PROFILE HEAD SUPPORT

(15mm behind neck)

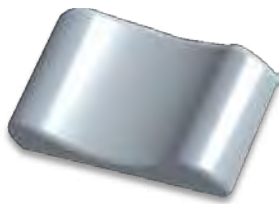

SNZAHRLP

STANDARD HEAD SUPPORT

(50mm behind neck)



SNVAHRVIN

DEEP CONTOUR HEAD SUPPORT

(15mm behind neck and 130mm deep lateral)



SNZAHRLS

Snooza Medial Thigh Support

STANDARD MEDIAL THIGH SUPPORT



SHORT MEDIAL THIGH SUPPORT

(for use with leg-rests)



SIZE	CODE	
1	SNZAPOMVIN1	
2	SNZAPOMVIN2	
1	SNZAPOMVIN1BLK	(black cover)
2	SNZAPOMVIN2BLK	(black cover)

SIZE	CODE	
1	SNZAPOMSVIN1	
2	SNZAPOMSVIN2	
1	SNZAPOMSVIN1BLK	(black cover)
2	SNZAPOMSVIN2BLK	(black cover)

NOTE: the Size 1 Medial Thigh Support fits both the Size 1 and 2 Snooza chairs • The Size 2 Medial Thigh Support fits both the size 3 and size 4 Snooza chairs

NOTE: the Size 1 Medial Thigh Support fits both the Size 1 and 2 Snooza chairs • The Size 2 Medial Thigh Support fits both the size 3 and size 4 Snooza chairs

Snooza Mobile Base



<i>SIZE</i>	<i>CODE</i>	<i>DESCRIPTION</i>
1	SNZAMOBAS1	Snooza Mobile Base Grey - 4 locking 50mm swivel castors - Size 1 (Suits sizes 1 and 2)
2	SNZAMOBAS2	Snooza Mobile Base Grey - 4 locking 50mm swivel castors - Size 2 (Suits sizes 3 and 4)
1	SNZAMOBAS1A	Snooza Mobile Base Grey - 4 locking 75mm swivel castors - Size 1 (Suits sizes 1 and 2)
2	SNZAMOBAS2A	Snooza Mobile Base Grey - 4 locking 75mm swivel castors - Size 2 (Suits sizes 3 and 4)
1	SNZAMOBAS1BLK	Snooza Mobile Base Black - 4 locking 50mm swivel castors - Size 1 (Suits sizes 1 and 2)
2	SNZAMOBAS2BLK	Snooza Mobile Base Black - 4 locking 50mm swivel castors - Size 2 (Suits sizes 3 and 4)
1	SNZAMOBAS1ABLK	Snooza Mobile Base Black - 4 locking 75mm swivel castors - Size 1 (Suits sizes 1 and 2)
2	SNZAMOBAS2ABLK	Snooza Mobile Base Black - 4 locking 75mm swivel castors - Size 2 (Suits sizes 3 and 4)

NOTE: the Size 1 Mobile Base fits both the Size 1 and 2 Snooza chairs • The Size 2 Mobile Base fits both the size 3 and size 4 Snooza chairs

Snooza Side Infill Pads

- Sold in pairs
- Reduces the width space for growth



SIZE	CODE	DESCRIPTION
1	SNZAIPADV1A	Snooza infil pads (P/R) for w/adjustment - vinyl covers - Size 1 Colour Apple
1	SNZAIPADV1B	Snooza infil pads (P/R) for w/adjustment - vinyl covers - Size 1 Colour Royal Blue
1	SNZAIPADV1BLK	Snooza infil pads (P/R) for w/adjustment - vinyl covers - Size 1 Colour Black
1	SNZAIPADV1GRY	Snooza infil pads (P/R) for w/adjustment - vinyl covers - Size 1 Colour Grey
1	SNZAIPADV1O	Snooza infil pads (P/R) for w/adjustment - vinyl covers - Size 1 Colour Orange
1	SNZAIPADV1P	Snooza infil pads (P/R) for w/adjustment - vinyl covers - Size 1 Colour Hot Pink
2	SNZAIPADV2A	Snooza infil pads (P/R) for w/adjustment - vinyl covers - Size 2 Colour Apple
2	SNZAIPADV2B	Snooza infil pads (P/R) for w/adjustment - vinyl covers - Size 2 Colour Royal Blue
2	SNZAIPADV2BLK	Snooza infil pads (P/R) for w/adjustment - vinyl covers - Size 2 Colour Black
2	SNZAIPADV2GRY	Snooza infil pads (P/R) for w/adjustment - vinyl covers - Size 2 Colour Grey
2	SNZAIPADV2O	Snooza infil pads (P/R) for w/adjustment - vinyl covers - Size 2 Colour Orange
2	SNZAIPADV2P	Snooza infil pads (P/R) for w/adjustment - vinyl covers - Size 2 Colour Hot Pink
3	SNZAIPADV3A	Snooza infil pads (P/R) for w/adjustment - vinyl covers - Size 3 Colour Apple
3	SNZAIPADV3B	Snooza infil pads (P/R) for w/adjustment - vinyl covers - Size 3 Colour Royal Blue
3	SNZAIPADV3BLK	Snooza infil pads (P/R) for w/adjustment - vinyl covers - Size 3 Colour Black
3	SNZAIPADV3GRY	Snooza infil pads (P/R) for w/adjustment - vinyl covers - Size 3 Colour Grey
3	SNZAIPADV3O	Snooza infil pads (P/R) for w/adjustment - vinyl covers - Size 3 Colour Orange
3	SNZAIPADV3P	Snooza infil pads (P/R) for w/adjustment - vinyl covers - Size 3 Colour Hot Pink
4	SNZAIPADV4A	Snooza infil pads (P/R) for w/adjustment - vinyl covers - Size 4 Colour Apple
4	SNZAIPADV4B	Snooza infil pads (P/R) for w/adjustment - vinyl covers - Size 4 Colour Royal Blue
4	SNZAIPADV4BLK	Snooza infil pads (P/R) for w/adjustment - vinyl covers - Size 4 Colour Black
4	SNZAIPADV4GRY	Snooza infil pads (P/R) for w/adjustment - vinyl covers - Size 4 Colour Grey
4	SNZAIPADV4O	Snooza infil pads (P/R) for w/adjustment - vinyl covers - Size 4 Colour Orange
4	SNZAIPADV4P	Snooza infil pads (P/R) for w/adjustment - vinyl covers - Size 4 Colour Hot Pink

Snooza Seat Accessories

SNOOZA BACK SUPPORT DEPTH ADJUSTMENT KIT

*(for seat-depth growth
adjustment)*

- Sold in packs of 2 (each packer is 35mm thick)



<i>SIZE</i>	<i>CODE</i>	<i>DESCRIPTION</i>
1	SNZABRDAK1	SNOOZA Back Support DEPTH ADJUSTMENT KIT - Grey Size 1
2	SNZABRDAK2	SNOOZA Back Support DEPTH ADJUSTMENT KIT - Grey Size 2
3	SNZABRDAK3	SNOOZA Back Support DEPTH ADJUSTMENT KIT - Grey Size 3
4	SNZABRDAK4	SNOOZA Back Support DEPTH ADJUSTMENT KIT - Grey Size 4
1	SNZABRDAK1BLK	SNOOZA Back Support DEPTH ADJUSTMENT KIT - Black Size 1
2	SNZABRDAK2BLK	SNOOZA Back Support DEPTH ADJUSTMENT KIT - Black Size 2
3	SNZABRDAK3BLK	SNOOZA Back Support DEPTH ADJUSTMENT KIT - Black Size 3
4	SNZABRDAK4BLK	SNOOZA Back Support DEPTH ADJUSTMENT KIT - Black Size 4

SNOOZA TRAY



<i>SIZE</i>	<i>CODE</i>	<i>DESCRIPTION</i>
1	SNZATRAY1	Snooza Padded Tray with grey vinyl cover - Size 1
2	SNZATRAY2	Snooza Padded Tray with grey vinyl cover - Size 2
3	SNZATRAY3	Snooza Padded Tray with grey vinyl cover - Size 3
4	SNZATRAY4	Snooza Padded Tray with grey vinyl cover - Size 4
1	SNZATRAY1BLK	Snooza Padded Tray with black vinyl cover - Size 1
2	SNZATRAY2BLK	Snooza Padded Tray with black vinyl cover - Size 2
3	SNZATRAY3BLK	Snooza Padded Tray with black vinyl cover - Size 3
4	SNZATRAY4BLK	Snooza Padded Tray with black vinyl cover - Size 4

Snooza Seat Accessories *cont.*



SNOOZA LEG REST

SIZE	CODE	DESCRIPTION
1	SNZALR1A	Snooza Leg rest complete with Vinyl cover - Size 1 Colour Apple
1	SNZALR1B	Snooza Leg rest complete with Vinyl cover - Size 1 Royal Blue
1	SNZALR1BLK	Snooza Leg rest complete with Vinyl cover - Size 1 Black
1	SNZALR1GRY	Snooza Leg rest complete with Vinyl cover - Size 1 Grey
1	SNZALR1O	Snooza Leg rest complete with Vinyl cover - Size 1 Colour Orange
1	SNZALR1P	Snooza Leg rest complete with Vinyl cover - Size 1 Colour Hot Pink
2	SNZALR2A	Snooza Leg rest complete with Vinyl cover - Size 2 Colour Apple
2	SNZALR2B	Snooza Leg rest complete with Vinyl cover - Size 2 Royal Blue
2	SNZALR2BLK	Snooza Leg rest complete with Vinyl cover - Size 2 Black
2	SNZALR2GRY	Snooza Leg rest complete with Vinyl cover - Size 2 Grey
2	SNZALR2O	Snooza Leg rest complete with Vinyl cover - Size 2 Colour Orange
2	SNZALR2P	Snooza Leg rest complete with Vinyl cover - Size 2 Colour Hot Pink
3	SNZALR3A	Snooza Leg rest complete with Vinyl cover - Size 3 Colour Apple
3	SNZALR3B	Snooza Leg rest complete with Vinyl cover - Size 3 Royal Blue
3	SNZALR3BLK	Snooza Leg rest complete with Vinyl cover - Size 3 Black
3	SNZALR3GRY	Snooza Leg rest complete with Vinyl cover - Size 3 Grey
3	SNZALR3O	Snooza Leg rest complete with Vinyl cover - Size 3 Colour Orange
3	SNZALR3P	Snooza Leg rest complete with Vinyl cover - Size 3 Colour Hot Pink
4	SNZALR4A	Snooza Leg rest complete with Vinyl cover - Size 4 Colour Apple
4	SNZALR4B	Snooza Leg rest complete with Vinyl cover - Size 4 Royal Blue
4	SNZALR4BLK	Snooza Leg rest complete with Vinyl cover - Size 4 Black
4	SNZALR4GRY	Snooza Leg rest complete with Vinyl cover - Size 4 Grey
4	SNZALR4O	Snooza Leg rest complete with Vinyl cover - Size 4 Colour Orange
4	SNZALR4P	Snooza Leg rest complete with Vinyl cover - Size 4 Colour Hot Pink

Snooza Seat Accessories cont.

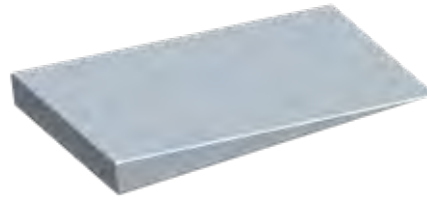

SNOOZA EXTRA BASE WEDGE

<i>SIZE</i>	<i>CODE</i>	<i>DESCRIPTION</i>
<i>1</i>	<i>SNZAWG1</i>	<i>Snooza Base Wedge complete with Grey Vinyl cover - Size 1</i>
<i>2</i>	<i>SNZAWG2</i>	<i>Snooza Base Wedge complete with Grey Vinyl cover - Size 2</i>
<i>3</i>	<i>SNZAWG3</i>	<i>Snooza Base Wedge complete with Grey Vinyl cover - Size 3</i>
<i>4</i>	<i>SNZAWG4</i>	<i>Snooza Base Wedge complete with Grey Vinyl cover - Size 4</i>
<i>1</i>	<i>SNZAWG1BLK</i>	<i>Snooza Base Wedge complete with Black Vinyl cover - Size 1</i>
<i>2</i>	<i>SNZAWG2BLK</i>	<i>Snooza Base Wedge complete with Black Vinyl cover - Size 2</i>
<i>3</i>	<i>SNZAWG3BLK</i>	<i>Snooza Base Wedge complete with Black Vinyl cover - Size 3</i>
<i>4</i>	<i>SNZAWG4BLK</i>	<i>Snooza Base Wedge complete with Black Vinyl cover - Size 4</i>